



SZ16-ZN/EN-A05

Adventurer 3 User Guide

This guide is only applicable to FLASHFORGE Adventurer3 3D printer

Content

Preface

Notice

Terms

Chapter 1: About Adventurer 3 _____ **06**

1.1 - Components Introduce	06
1.2 - Reference	07

Chapter 2: Operating _____ **08**

2.1 - Unpacking	08
2.2 - Accessories	10
2.3 - Interface	11
2.3.1 - Build	11
2.3.2 - Tools	13
2.3.2.1 - NetWork	13
2.3.2.2 - Preheat	16
2.3.2.3 - Setting	19
2.3.2.4 - About	20
2.3.3 - Filament	21
2.4 - Print	22
2.4.1 - Load Filament	22
2.4.2 - Model File Transfer	24
2.4.3 - Print	29
2.4.3.1 - FlashCloud Print	29
2.4.3.2 - PolarCloud Print	31
2.4.4 - Model Remove	35
2.4.5 - Replace Filament	36
2.5 - The Guide of Using Camera	37
2.5.1 - The Switching Can Be Controlled by the Lower Computer	37
2.5.2 - FlashCloud Camera Use	38
2.5.3 - PolarCloud Camera Use	40
2.5.4 - The Switching Can Be Controlled Through the Cloud	42
2.5.5 - Error Handling	44

Chapter 3: Q&A _____ **37**

Chapter 4: Supports and Service _____ **40**

Preface

Note: Each device must be tested before leaving factory. If there are some residues in extruder or some tiny scratches on the build tape, it is normal and won't affect the printing quality.

On the completion of this User Guide, thanks all FlashForge engineers and the FlashForge 3D printer users for their unremitting efforts and sincere assistance.

The FlashForge Adventurer 3 User Guide is designed for the Adventurer 3 users to start their printing journey with FlashForge Adventurer 3. Even if you are familiar with earlier FlashForge machines or 3D printing technology, we still recommend that please read this guide, as there is lots of important information about the Adventurer 3 for you to get a better 3D experience.

For a better and more successful printing experience, you can refer to the following materials:

Quick Start Guide:

Users will find the Quick Start Guide together with the printer accessories. The Quick Start Guide will help you start your print journey as soon as possible.

Official FlashForge Website: www.flashforge.com

The official FlashForge website contains the up-to-date information concerning FlashForge software, firmware, device maintenance and so on. Users are also able to get the contact information from there.

Notice

Safety Notice: PLEASE READ AND STRICTLY FOLLOW ALL THE SAFETY WARNINGS AND NOTICE BELOW.

Work Environment Safety

- ◆ Keep your work place tidy.
- ◆ Do not operate Adventurer 3 in the presence of flammable liquids, gases or dust.
- ◆ Keep Adventurer 3 out of children and untrained people's reach.

Electrical Safety

- ◆ Always use the Adventurer 3 with a properly grounded outlet. Do not refit Adventurer 3 plug.
- ◆ Do not use Adventurer 3 in damp or wet locations. Do not expose Adventurer 3 to burning sun.
- ◆ In case of device damage, please use the power supply provided by FlashForge.
- ◆ Avoid using the device during a thunderstorm.
- ◆ In case of uncertain accident, please unplug the device if you do not use it for long.

Personal Safety

- ◆ Do not touch the nozzle and build plate during printing.
- ◆ Do not touch the nozzle after finishing printing.
- ◆ Dress properly. Do not wear loose clothing or jewelry. Keep your hair, clothing and gloves away from moving parts.
- ◆ Do not operate the device while you are tired or under the influence of drugs, alcohol or medication.

Cautions

- ◆ Do not leave the device unattended for long.
- ◆ Do not make any modifications to the device.
- ◆ To lower the build plate before loading/unloading filament.
(The distance between the nozzle and build plate should be kept for at least 50mm)
- ◆ Operate the device in a well-ventilated environment.
- ◆ Never use the device for illegal activities.
- ◆ Never use the device to make any food storage vessels.
- ◆ Never use the device to make any electrical appliance.
- ◆ Never put the model into your mouth.
- ◆ Do not remove the models with force.

Wireless Communications

- ◆ Wi-Fi frequency: 2.4G
- ◆ CPU (MT7688) frequency: 580MHZ
- ◆ Frequency band(s) in which the radio equipment operates: 2.4-2.4835GHZ
- ◆ The maximum radiated transmitter power: 14-18 DBM
- ◆ Wi-Fi is for transfer printing model file and connect with FLASHPRINT software or print cloud.

- ◆ The computer connects to the device via WIFI to download the printed model. Connect to the cloud platform through wifi, you can check the printing status, transfer the printing documents and control the printer.

Environment Requirements

- ◆ Temperature: RT 15–30°C; Moisture: 20%–70%

Place Requirements

- ◆ The device must be placed in a dry and ventilated environment. The distances of the left, right and back side space should be at least 20cm, and the distance of the front side space should be at least 35cm. Device storage temperature: RT 0–40°C

Filament Requirements

- ◆ Do not abuse the filament. Please make sure you use the FlashForge filament or the filament from the brands accepted by FlashForge. Nozzle clogging and damage may be caused by non-FlashForge filament due to inappropriate material properties.

Filament Storage

- ◆ All polymers degrade with time. Do not unpack filament until necessary. Filament should be stored at clean and dry conditions.

Legal Notice

- ◆ All the information in this document is subject to any amendment or change without the official authorization from FlashForge.
- ◆ FLASHFORGE CORPORATION MAKES NO WARRANTY OF ANY KIND WITH REGARD TO THIS DOCUMENT, INCLUDING, BUT NOT LIMITED TO, THE IMPLIED WARRANTIES OF MERCHANTABILITY AND FITNESS FOR A PARTICULAR PURPOSE.
- ◆ FCC Notice
This device complies with part 15 of the FCC Rules. Operation is subject to the following two conditions: (1) This device may not cause harmful interference, and (2) this device must accept any interference received, including interference that may cause undesired operation.
- ◆ FlashForge shall not be liable for errors contained herein for incidental consequential damages in connection with furnishing, performance or use of this material.
- ◆ This document contains proprietary information protected by copyright.
Copyright © 2017 FlashForge Corp. All Rights Reserved.

Terms

Build Plate	The surface on which the Adventurer 3 builds an object.
Build Tape	The black tape that covers Adventurer 3's build plate so that the object can stick to the build plate well.
Build Volume	The three dimensional amount of space that an object will use once it is completed. The largest build volume is 150*150*150mm.
Extruder	The integral extruder device installed on X-Axis. Extruder draws the filament from the spool, melts it and pushes it through a nozzle into the build plate.
Nozzle	Also called "print head", which located at the bottom of the extruder where heated filament is squeezed out.
Cooling Fan	To cool the outer assembly of the extruder and gear motor.
Filament Cartridge	A specific box for placing FlashForge filament, which is located on the right of printer.
Filament Guide Tube	A white plastic tube that guides the filament from the filament box to the filament intake.
Filament Intake	An opening located at the top of the extruder.
Solid Glue Stick	A solid adhesive used for making the model stick to the build plate firmly.

Chapter 1: About Adventurer 3

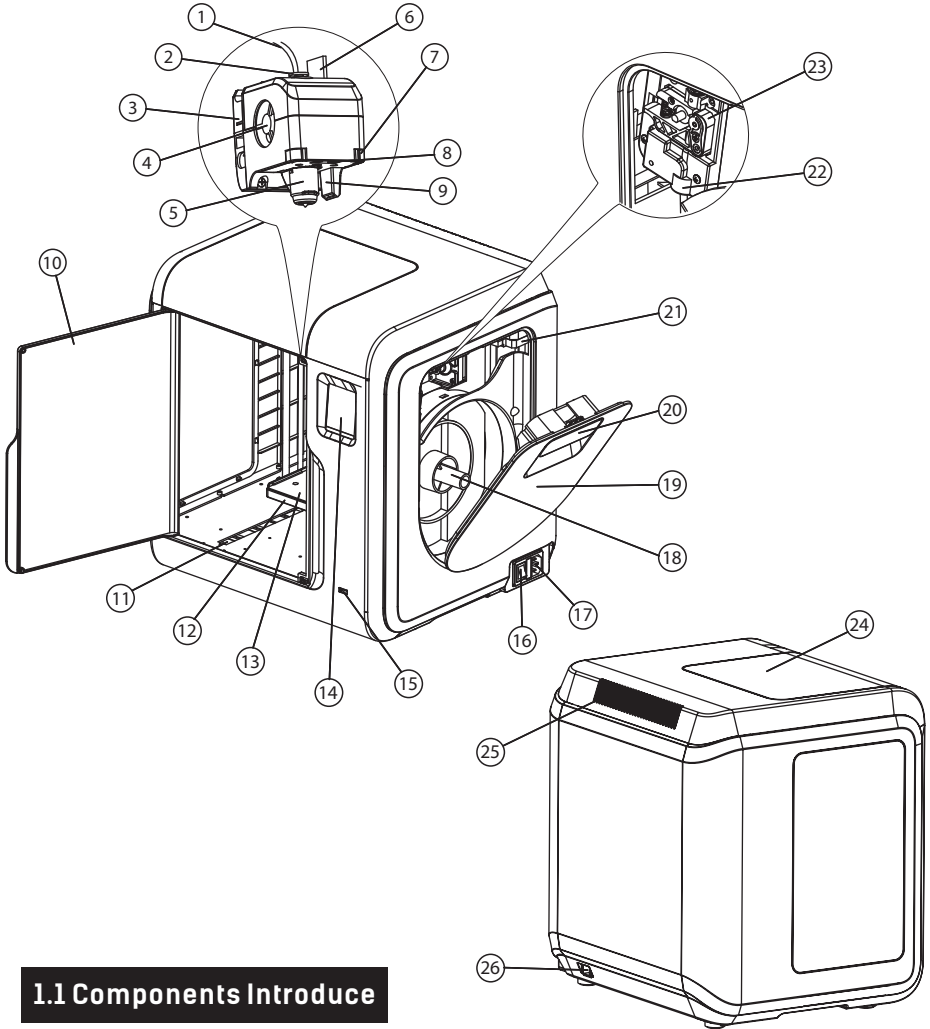

1.1 Components Introduce

- 1. Filament guide tube 2. Filament guide tube joint 3. Extruder base 4. Cooling Fan
- 5. Removable nozzle 6. Extruder cables 7. Clip 8. Led light
- 9. Air guide 10. Front door 11. Y-Axis sliding slot 12. Platform base
- 13. Removable build plate 14. Touch-screen 15. USB stick input 16. Power switch
- 17. Power input 18. Spool holder 19. Filament cover 20. Filament cover handle
- 21. Moto 22. Filament intake 23. Filament feeding wheel 24. Top cover
- 25. Air outlet 26. Ethernet input

1.2 Reference

Name	Adventurer 3
Number of Extruder	1, Removable
Print Technology	Fused Filament Fabrication (FFF)
Screen Size	2.8" color IPS Touch Screen
Build Volume	150×150×150mm
Layer Resolution	0.1–0.4mm
Build Accuracy	±0.2mm
Positioning Accuracy	Z axis 0.0025mm; XY axis 0.011mm
Filament Diameter	1.75mm (±0.07mm)
Nozzle Diameter	0.4mm
Build Speed	10~100 mm/s
Software	FlashPrint
Support Formats	Input: 3mf/stl/obj/fpp/bmp/png/jpg/jpeg File Output: gx/g File
Memory Size	8G
OS	Win xp/Vista/7/8/10, Mac OS, Linux
Device Power	<120W
Connectivity	USB stick, WiFi, Ethernet
Device Size	388×340×405mm
Net Weight	9 kg

Chapter 2: Operating

2.1 Unpacking

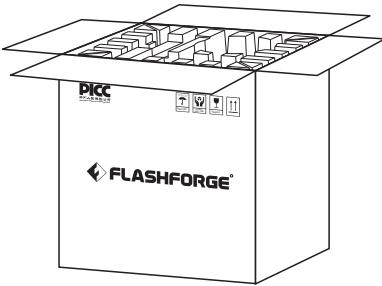

1. Open the box.

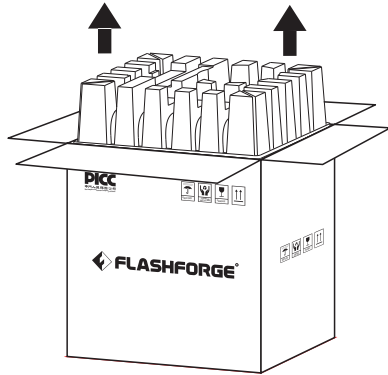

2. Take out the wrapping paper box on the top.

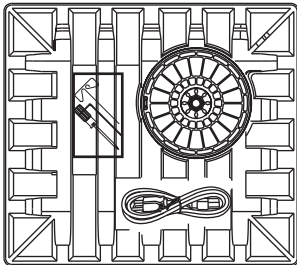

3. Be careful! Filament, build tape, solid glue, scraper and power cable are all placed inside the wrapping paper box.

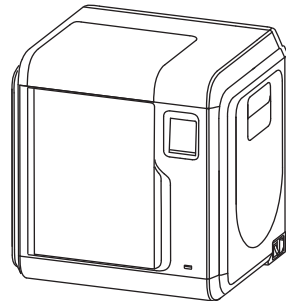

4. Take out the printer from the box.

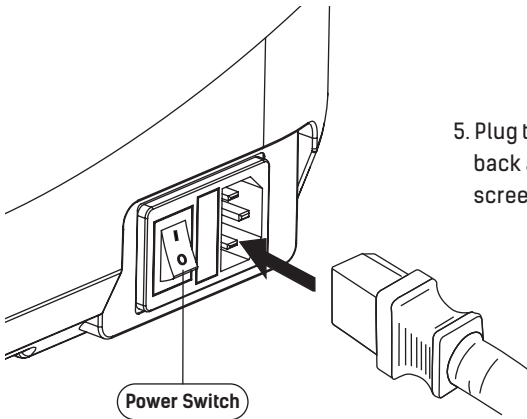

5. Plug the power cable into the input on the back and turn on the power switch, the touch screen is turned on.

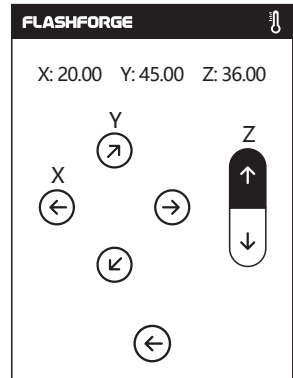
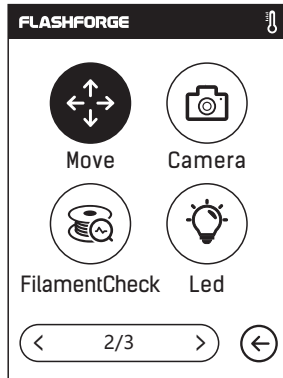
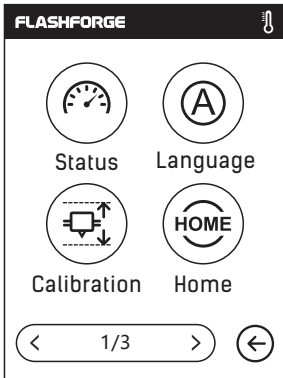

6. Click [tools]-[setting] in turn to enter page like this, turn to page two, click [move]. Click the upper arrow in the moving page to make the extruder raises for removing the paper box on the bottom easier.

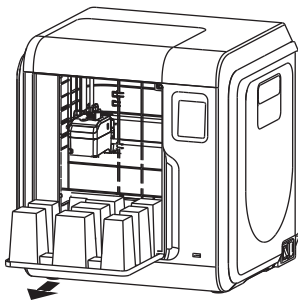

7. Open the front door, take out the paper box inside the printer, printer unpacking completed.

2.2 Accessories

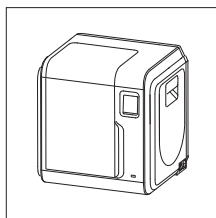

3D Printer

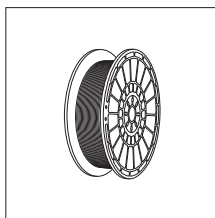

Filament

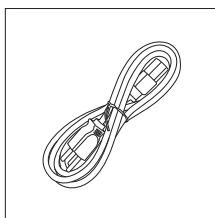

Power Cable

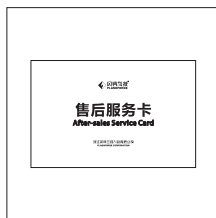

After-sales
service card

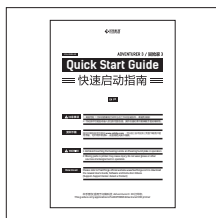

User Guide

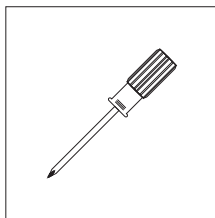

Screwdriver

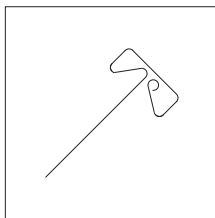

Unclogging Pin Tool

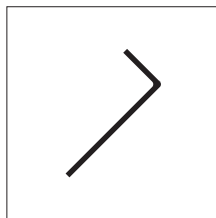

Allen Wrench

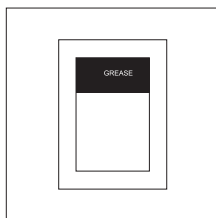

Grease

2.3 Interface Menus Introduction

2.3.1 Build

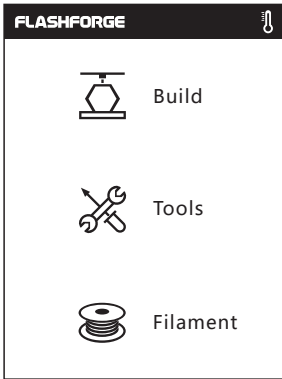

1. Tap [Print].

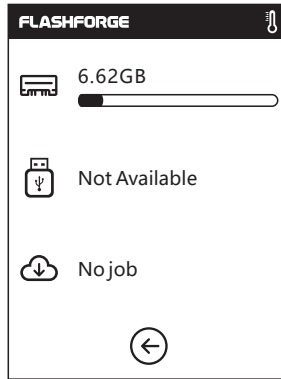

Read the print file from:
The local memory card

The USB stick

The Cloud

Back: Back to upper interface

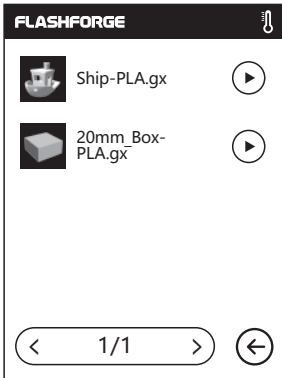

2. Choose the read path of the print file File list.

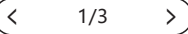

3. File list

Tap  to begin printing; tap the picture of the selected file to enter file details.

Page-flip: Tap the left/right arrow. 

Long press the file picture or file name, quit out multi-selected interface, you can select all, copy , delete .

Tap  to quit out multi-selected interface.

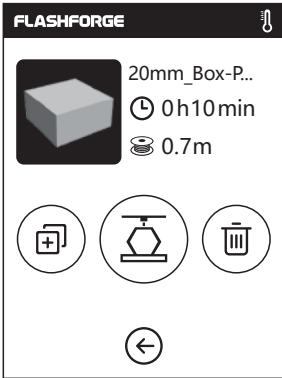

File details: Including file picture, time needed, filament needed.



Build: To begin printing the file.



Copy: To copy the files to the local memory card from the USB stick.



Delete: To delete the print file.

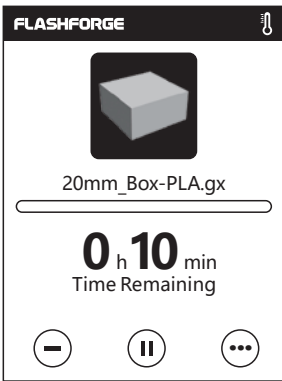

Print interface



Cancel: To cancel the print job.



Pause/Resume: To suspend or resume the print job.



More: To check more settings and details information during printing.

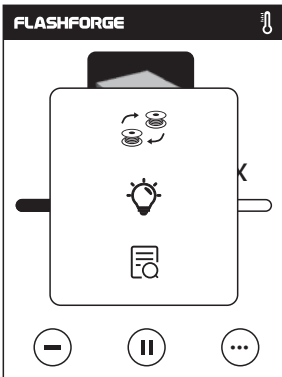

More

Replace: To change filament during printing progress.

Led Light: To turn on or turn off the led light.

Detail: To check more detail information.

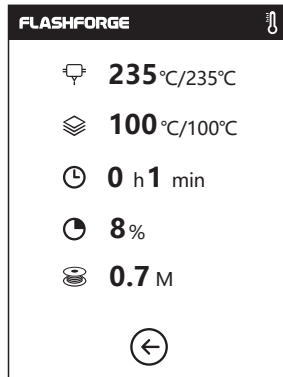

Details



Extruder temperature



Build plate temperature



Used time







Printing progress

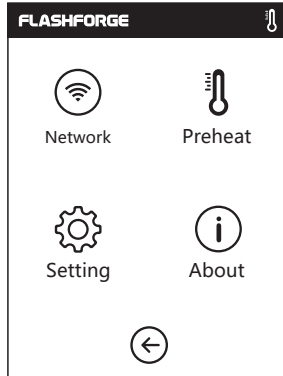
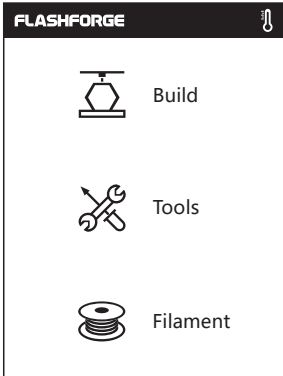

Whole filament needed

2.3.2 Tools





-  **Network:** To connect printer to your PC or internet.
-  **Preheat:** To preheat the extruder and build plate.
-  **Setting:** To implement relevant function setups.
-  **About:** Information about the printer.

2.3.2.1 Network

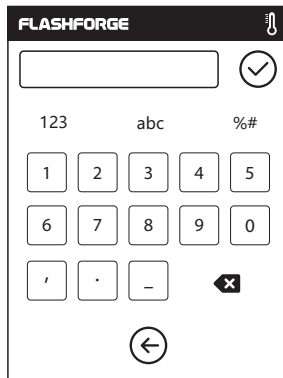
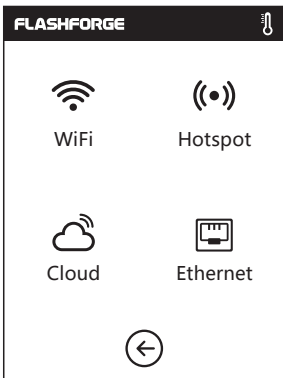
WiFi



-  **ON/OFF:** To turn on/off the WIFI connection.
-  **WiFi connection:** To connect your printer with your PC via a stable WIFI signal.

Hotspot

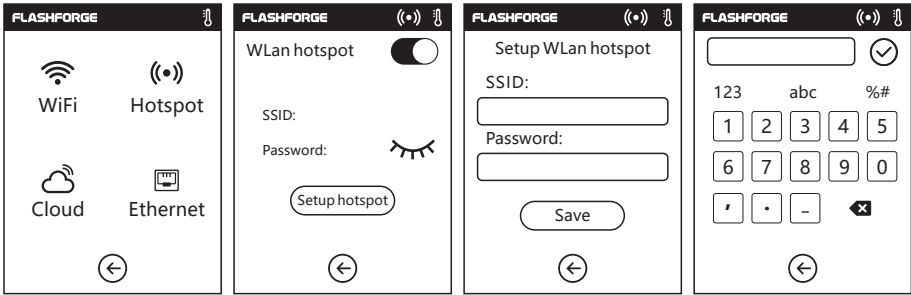

☰ To set your printer as a WLAN hotspot.

🔘 Turn on/off the WLAN hotspot.

Hotspot setting: To set the hotspot name and password. Input hotspot name with numbers, characters and symbols.

☑ Tap to save the name and password.

Ethernet Connection

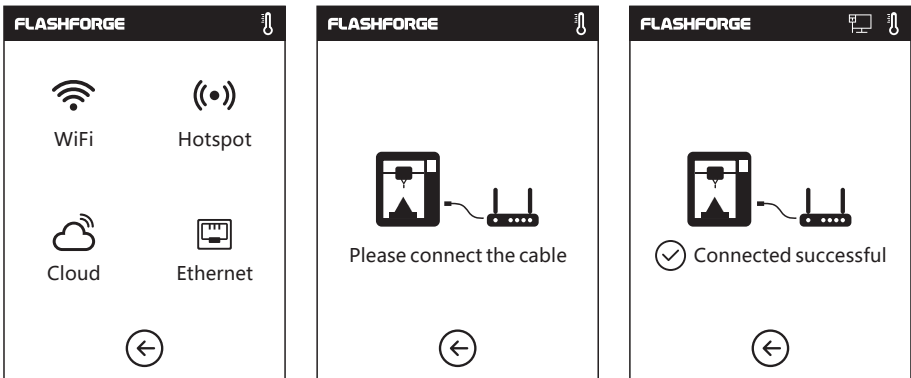

To connect your printer with your PC via Ethernet cable.

Cloud Connection

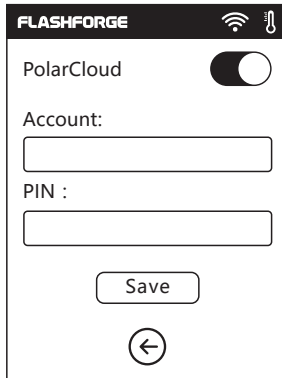
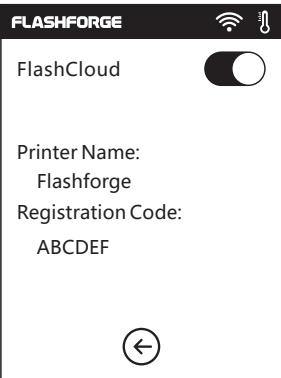
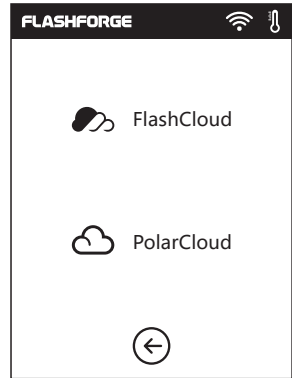
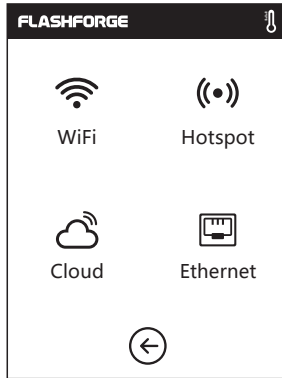
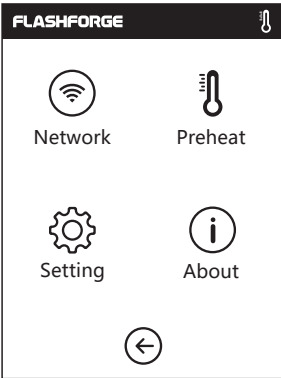

1. Turn on the WiFi or Ethernet connection, connect the printer to internet successfully.
2. Tap[Tools]-Tap[Network]-Tap[Cloud] on the printer;
3. Turn on the Cloud Connection function;
4. Register your cloud account and set your settings on <https://cloud.sz3dp.com> with the registration code on printer's touch screen, or register your cloud account on <https://polar3d.com> to get your polar3d account and pin code.

2.3.2.2 Preheat setting

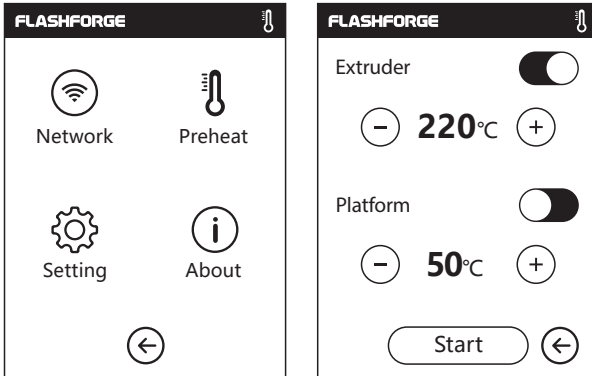

ON/OFF: Turn ON/OFF the extruder or platform preheat;

Tap (+) (-) symbol, you could set preheat temperature;

Long press (+) (-) symbol, set preheat temperature rapidly;

Extruder/Platform preheat interface

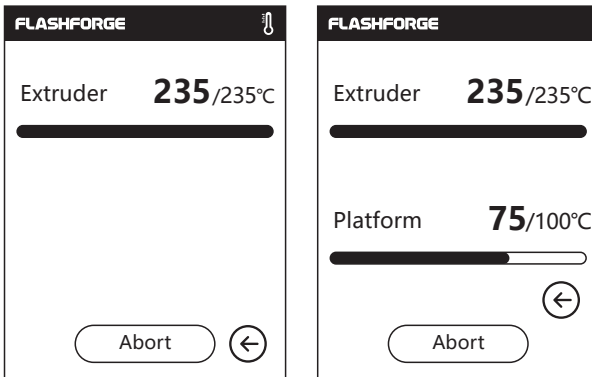

It contains actual temperature, target temperature and heating progress.

Extruder highest preheat temperature: 240°C

Platform highest preheat temperature: 100°C

Tap (Abort) : Abort the preheat job.

2.3.2.3 Setting

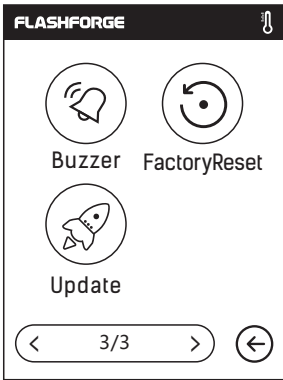
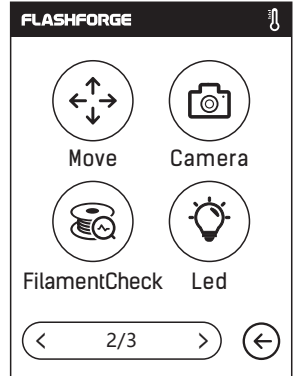
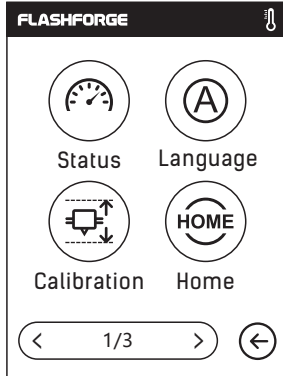
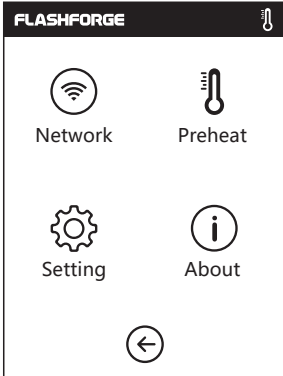

Setting interface

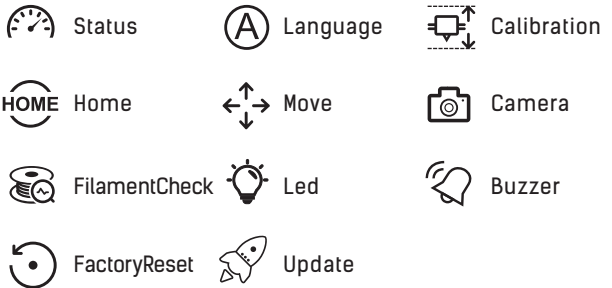

Status

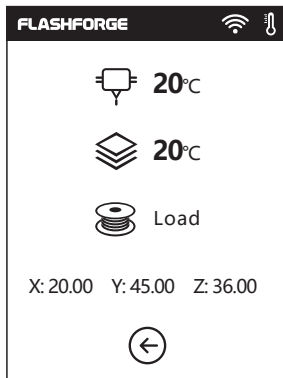
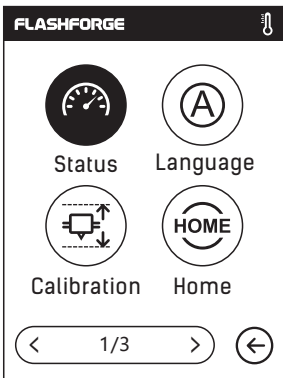

 It displays the real-time coordinates of X-axis, Y-axis, Z-axis and the real-time temperature of extruder and platform.

Language

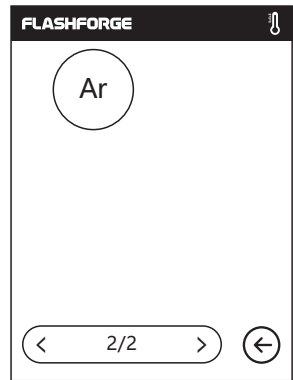
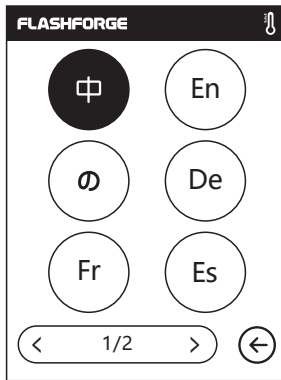
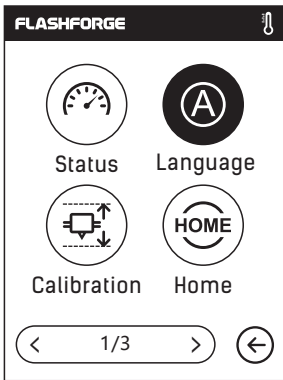

Choose the target language.

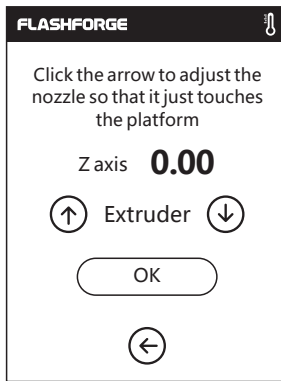
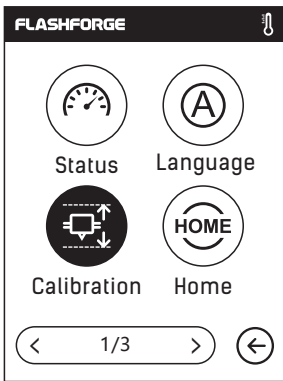

Calibration

To calibrate the initial distance between extruder and platform. After homing completed, slide the piece of paper continuously back and forth between the nozzle and the build plate. And simultaneously manually tap up and down arrow to adjust the distance until the paper causes a slight friction. Tap [OK] to complete calibration.

⬆️ Up arrow: Extruder will elevate, away from the platform;

⬇️ Down arrow: Extruder will descend, move close to the platform;

Home

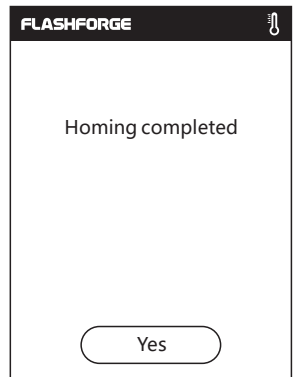
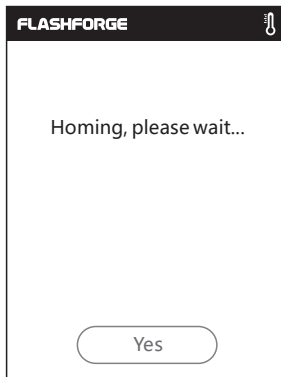
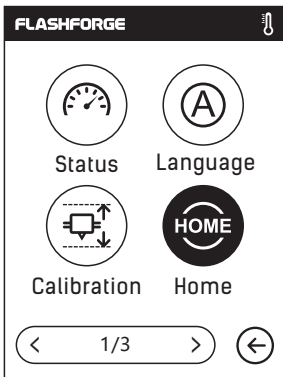

 To make the X, Y and Z axes back to the mechanical zero point.

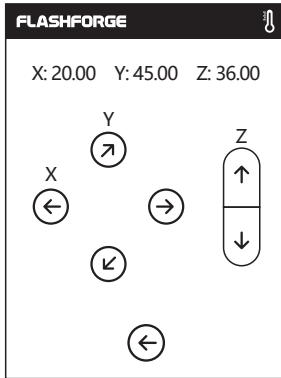
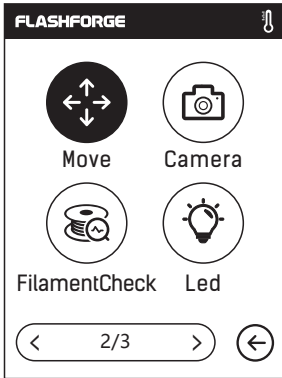

Manual:

To manually adjust the positions of extruder and build plate.

- Extruder moves to the right;
- Extruder moves to the left;
- Build plate moves to the front;
- Build plate moves to the back;
- Extruder moves upward;
- Extruder moves downward;

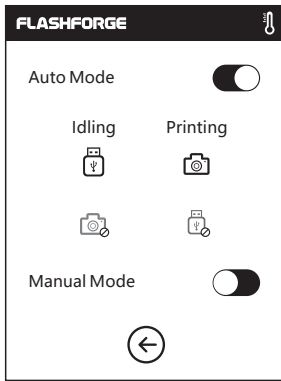
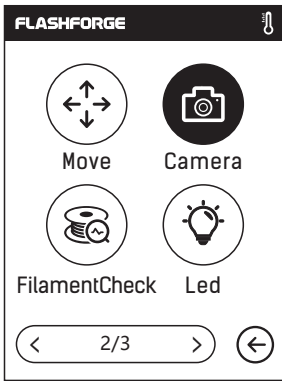

Camera:

Turn on or turn off the camera.

Auto Mode:

Printing: Camera is on; USB stick is off
 Idling: Camera is off; USB stick is on

Manual Mode:

Users choose camera is on or USB stick is on, when one of them is on, the other is off.

Note: when using cloud print and using camera function on cloud, camera will be on manual mode, USB stick will be off; turn on the auto mode on printer if you want to turn off the manual mode.

More details about Camera, please check Chapter 2.5.

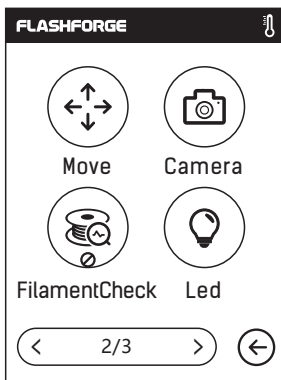
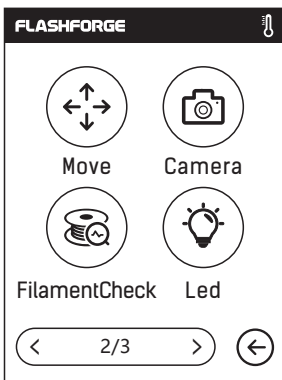



Filament check:

To turn on/off the filament check, notice will pop out when filament is used up or suspended when the check is turned on.

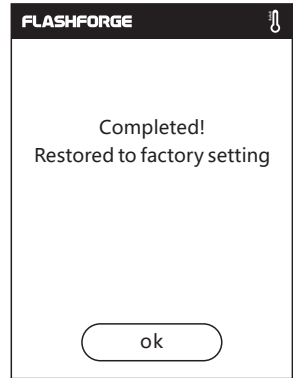
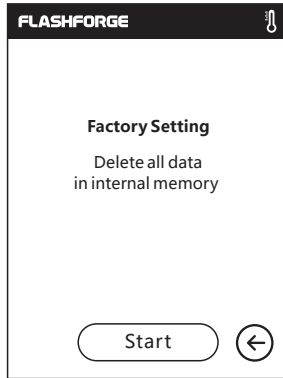
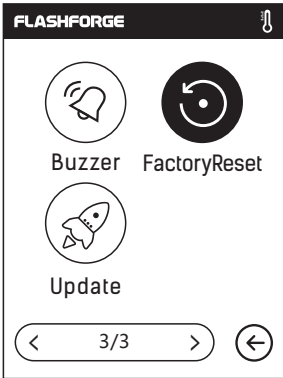

Led: To turn on/off the light.



 **Factory Setting:** Delete all data in internal memory, return the printer to factory setting.

 **Buzzer:** To turn on/off the buzzer.

 **Update:** To upgrade the newest firmware.

2.3.2.4 About:

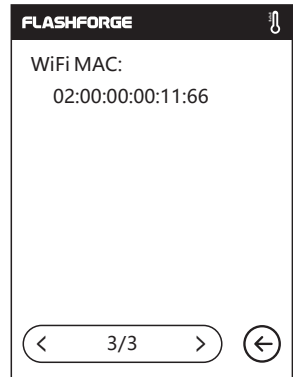
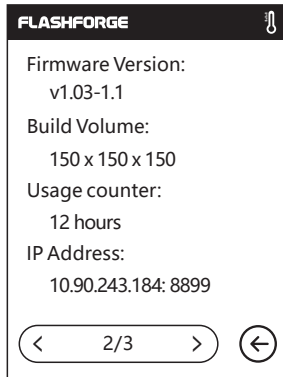
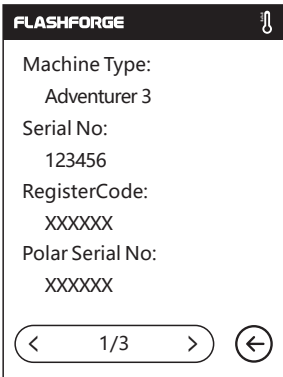

Shows the basic information about the printer.

Notice: When contacting after-sales support, please give your Serial No to after-sales engineer, which is showed in the [About] interface.

2.3.3 Filament

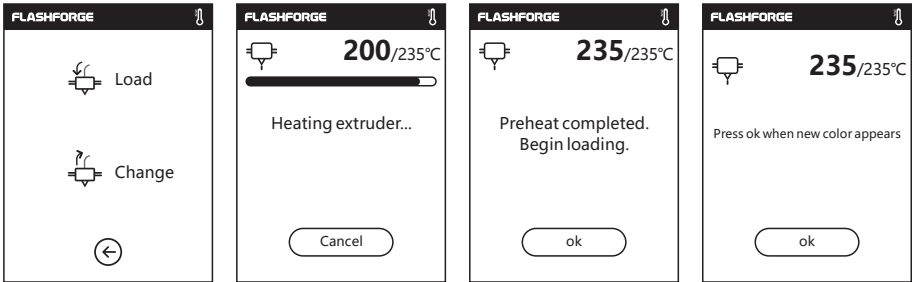

Load

- The extruder is heated up to 220°C.
- After heat completed, insert the filament into the extruder at an upright angle until some resistance is sensed (as the filament is pushed through the feeding wheel).
- Load will complete when you see filament come out of extruder.

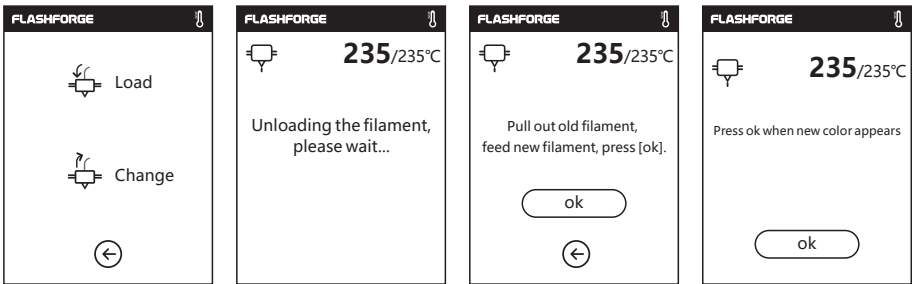

Change

- The extruder is heated up to 235°C, after heat completed, filament will be unloaded from the extruder.
- Pull out the filament according to the instruction.
- Insert new filament into the filament intake, tap [OK];
- New filament will be pushed into the extruder, replace will complete when you see new filament come out of extruder.

2.4 Print

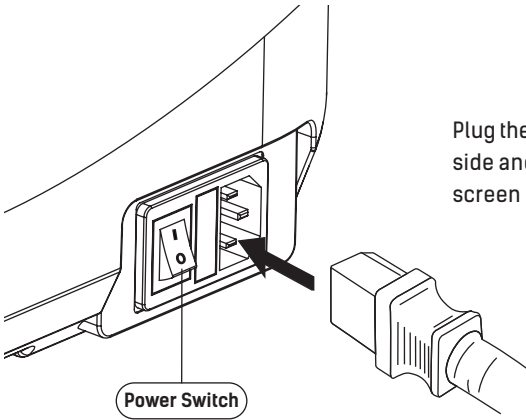

Plug the power cable into the input on the right side and turn on the power switch, the touch screen is turned on.

2.4.1 Load Filament

1. Open the filament cover, insert the filament into the filament intake, push filament into the feeding wheel until some resistance is sensed.

Note: Please make sure filament has been pushed into the feeding wheel!

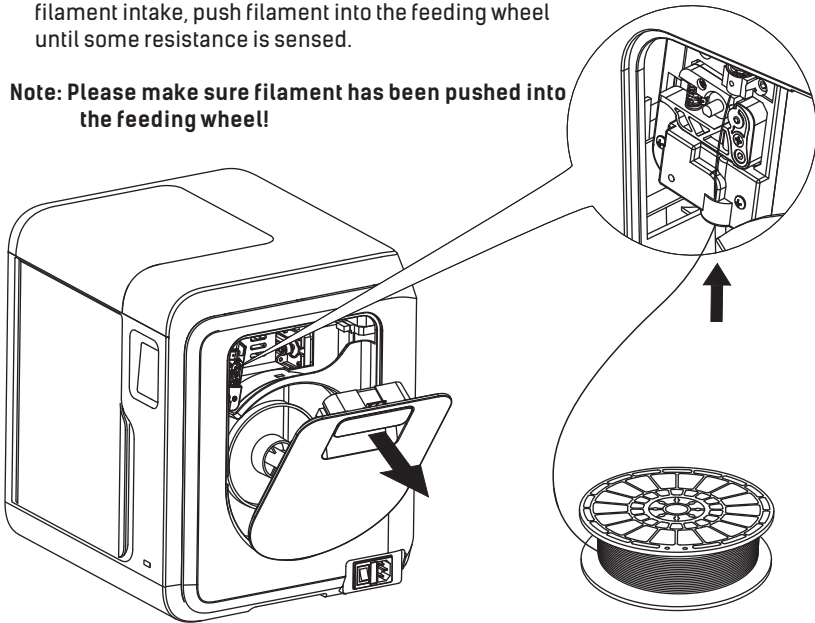

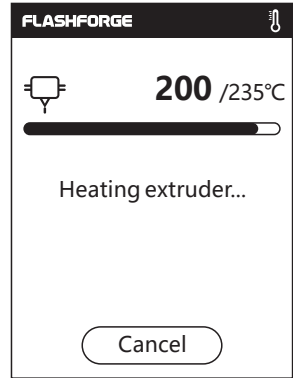
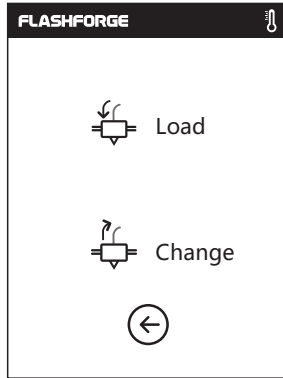
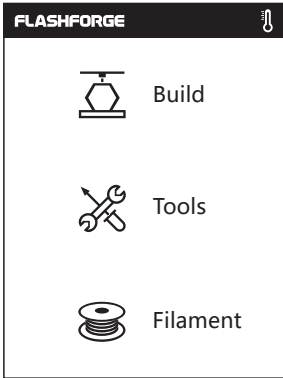

2. Tap [Filament]--Tap [Load]--After Load completed--Tap [OK]

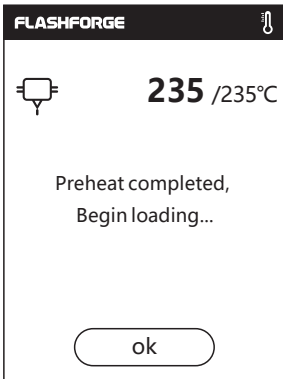

3. Load completed when you see filament come out of extruder, Tap [OK].
Put the spool of filament on the spool holder, close the filament cover.

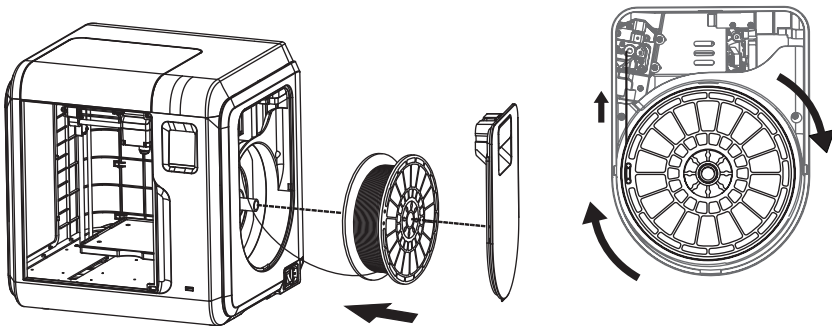

Mind the loading direction of filament, make sure to be clockwise as the picture showed.

2.4.2 Model File Transfer

After generating the Gcode file, you can transfer it to your Adventurer 3 with different network methods. If use USB stick to print, please insert your USB stick with target .g/.gxl file to your Adventurer 3, there will be no need to set new network.

Method 1 :

WiFi Connection

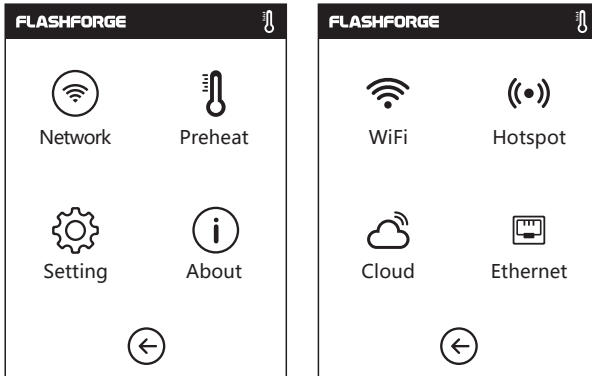

1. Tap [Tools]--Tap [Network]--Tap [WIFI] ;

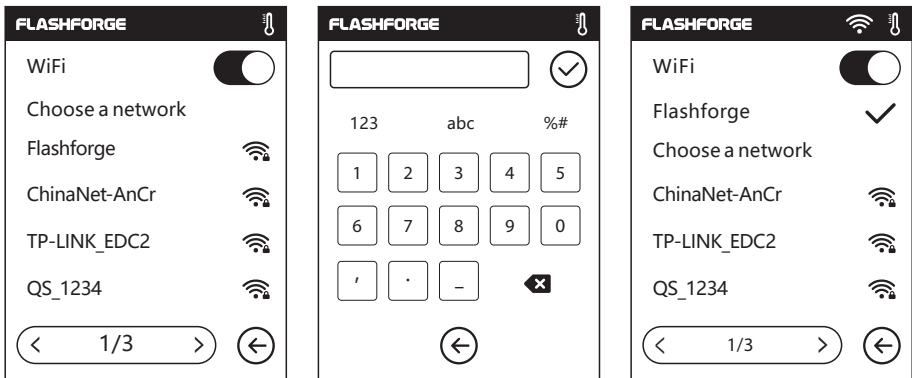

2. Choose a network and input the password.

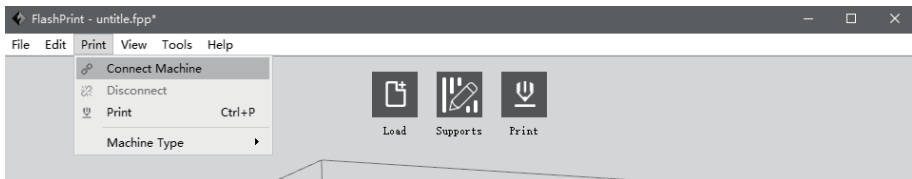

3. Open the FlashPrint software, click [Print], then click [machine type], select [Flashforge Adventurer III]. Then click [connect to the machine].

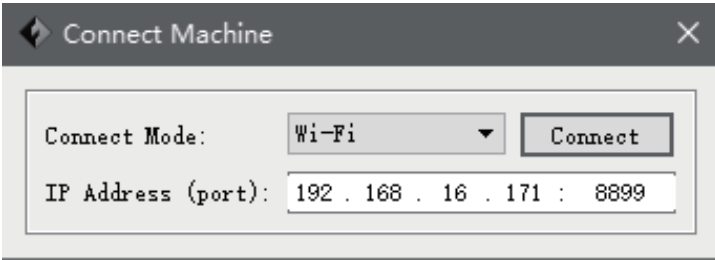

4. In the pop up dialog box, the connection mode selects Wi-Fi, and fill in the IP port column with the IP address of the printer. Query IP address clicking [tools] – [about], turn to next page, you can see the IP address. Input completion and click connect.

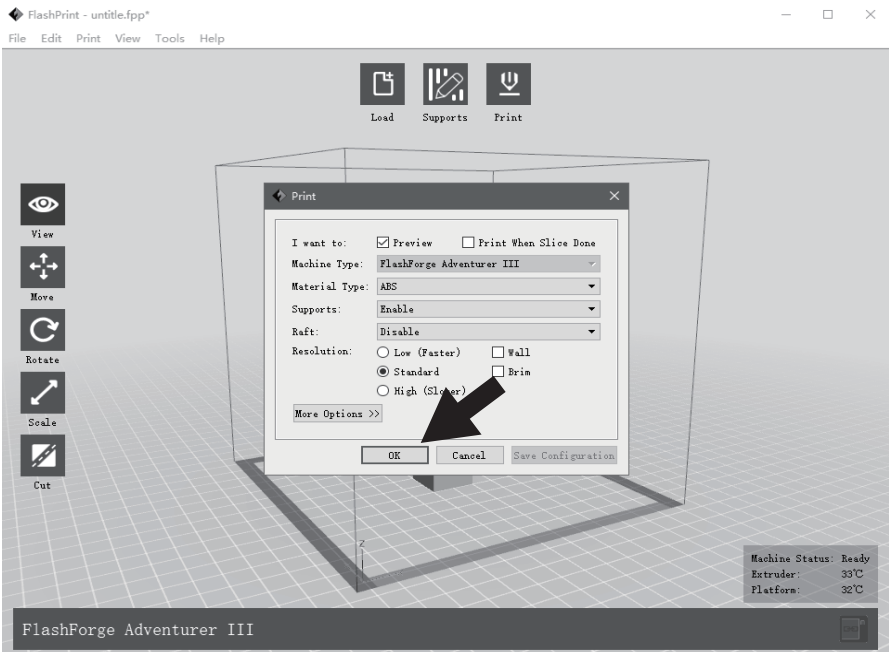

5. When the connection is succeed, the machine status bar will appear in the lower right corner of the software interface, and the printer icon will be displayed as a connected state. After processing the model in FlashPrint software, click the top print icon. Click [OK]. Select the appropriate location to save the slice processed files.

Notices

When the user wants to use the browser to view the images, the printer and PC must be in an intranet (that is, the printer and PC connect to the same router).

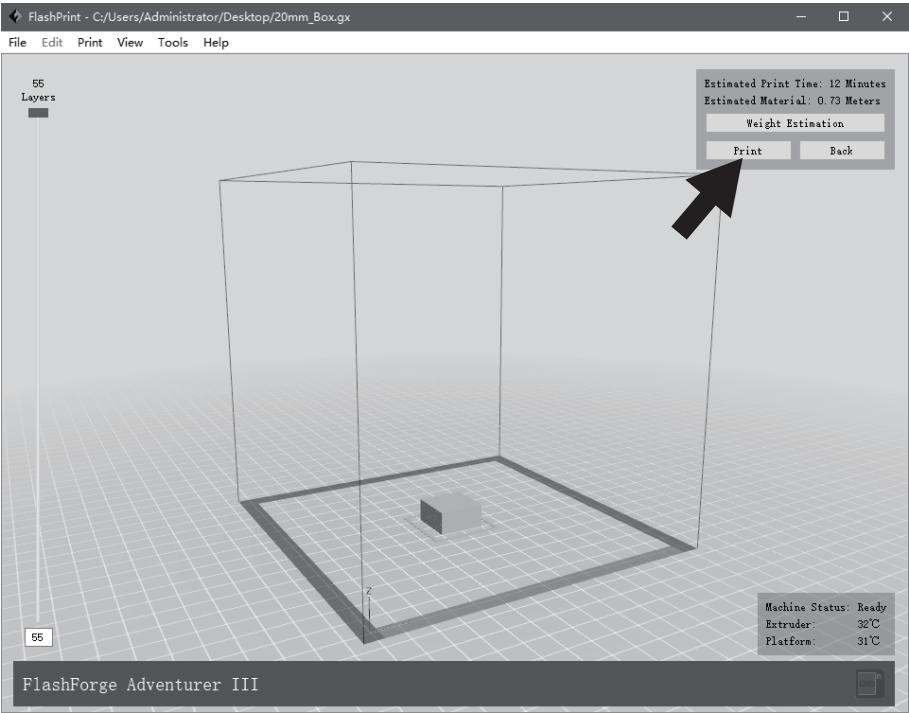

5. After the software slicing is completed, click [Print]. Then the printer starts preparatory work such as preheating, and automatically starts printing after it is ready.

Method 2: Cloud Connection

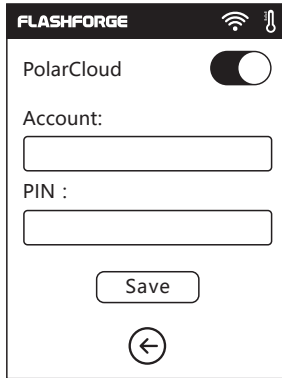
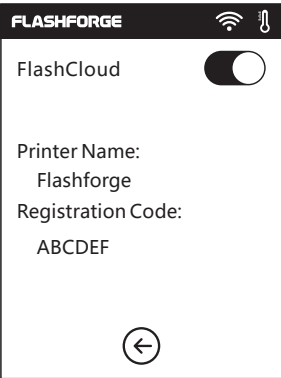
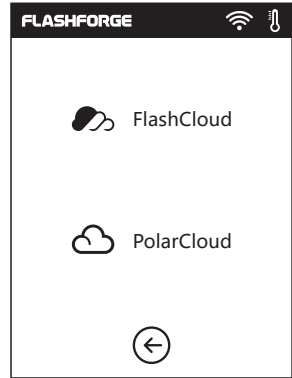
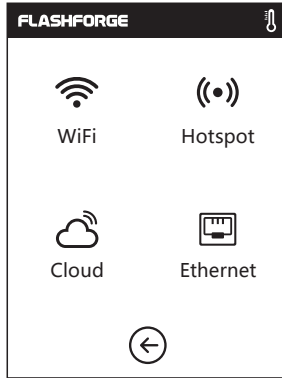
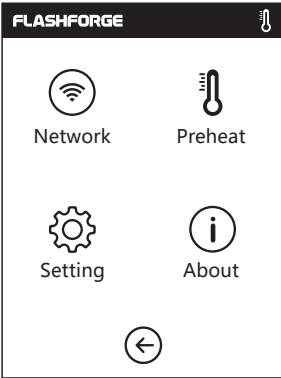

Use the cloud connection to process printing operation.

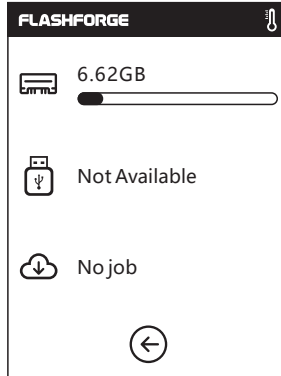
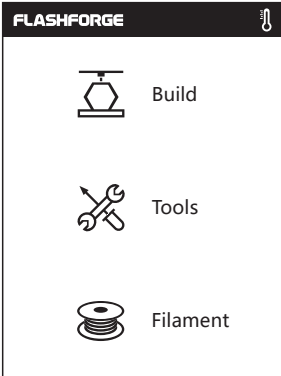

* The use of FlashForge cloud is in 2.4.3.1 section.

2.4.3 Print

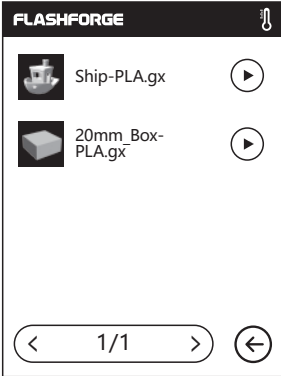

1. Tap [Build], choose the file path: Printer internal memory, USB stick, Cloud.



2. Choose the model file, tap  on its right to start printing; or tap model picture or model name to enter detail page, tap  to start printing.

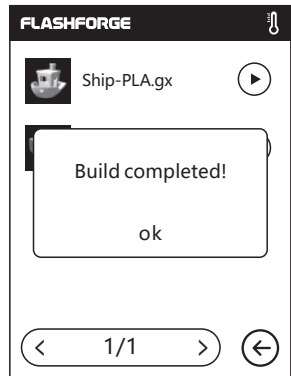
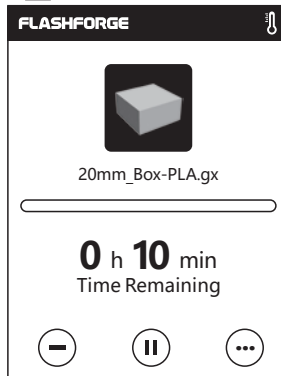
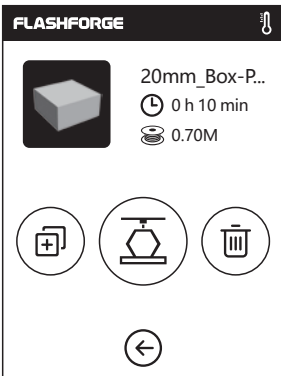

3. Extruder will heat up automatically, when heating finishes, the printer will start to build the model. After printing completed, printer will sound a beep and pop out a notice on the touch screen.

2.4.3.1 FlashCloud Print



FlashCloud : Cloud.sz3dp.com

1. Register your account on Flashforge cloud:
After activate your account through your email box,
login in Flashforge cloud with your account.

Login

E-mail

Password

Remember Password

[Forgot password](#) [Register](#)

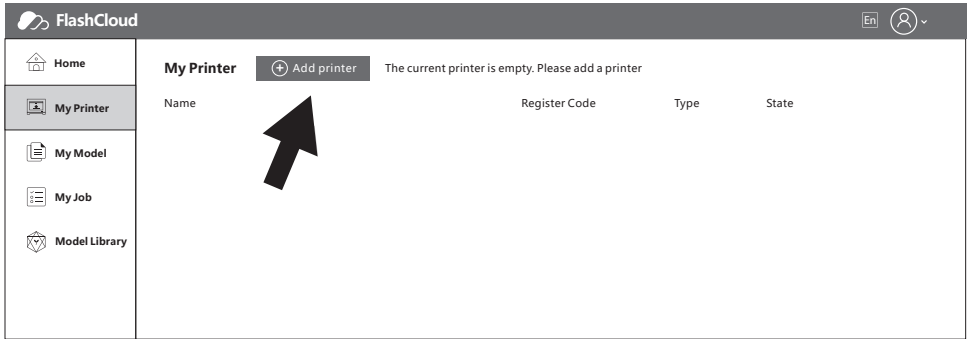

2. After login in cloud with your own account, click [My Printer] – click [Add Printer].

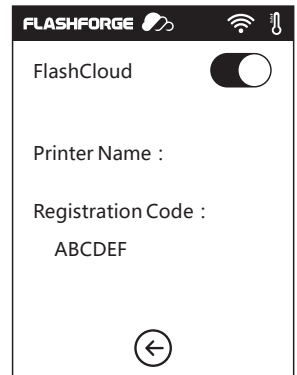
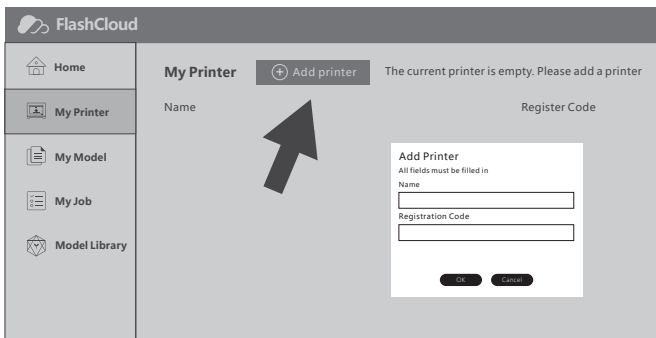

3. Input your printer's name and Flashcloud registration code in [Add printer] interface. These information are shown in your printer's FlashCloud interface.

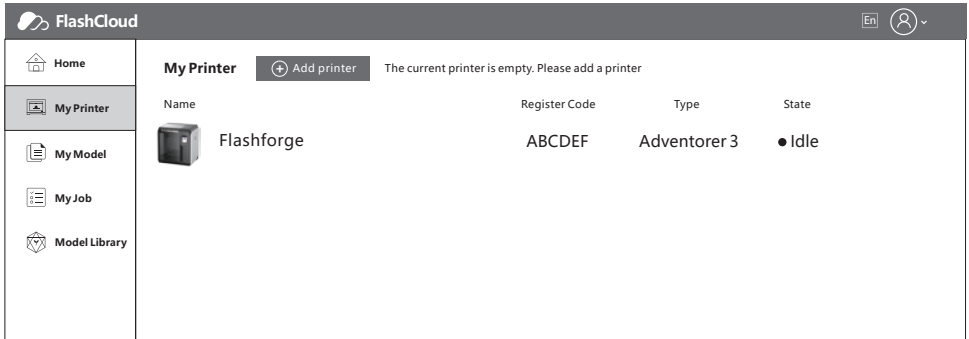

4. Add printer completed.

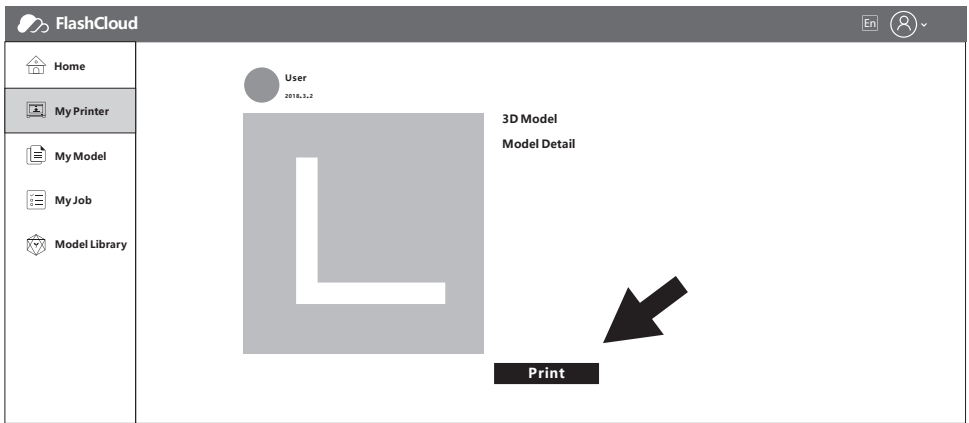

5. Choose a model from cloud model library or upload your own model (stl file), click [Print], enter the edit model interface to edit model.

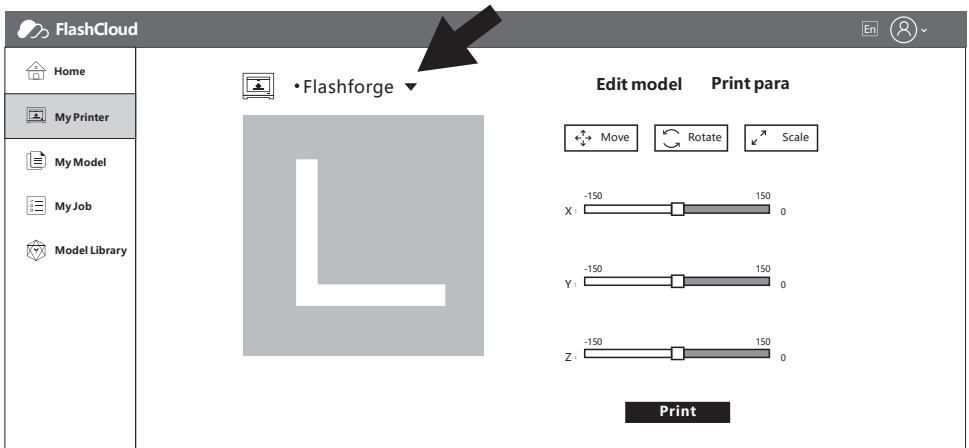

6. In the drop down menu of the printer's name, you can choose the printer which runs this mission. (the printer must be added into 'my printer')

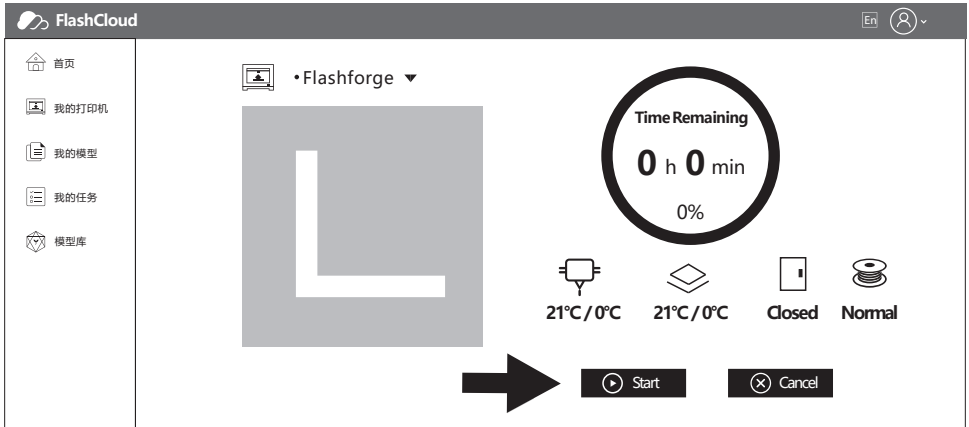

2.4.3.2 Polar云打印

1. Register Polar cloud account.
Log in <https://polar3d.com> to register the account.



2. Query Polar cloud PIN code.

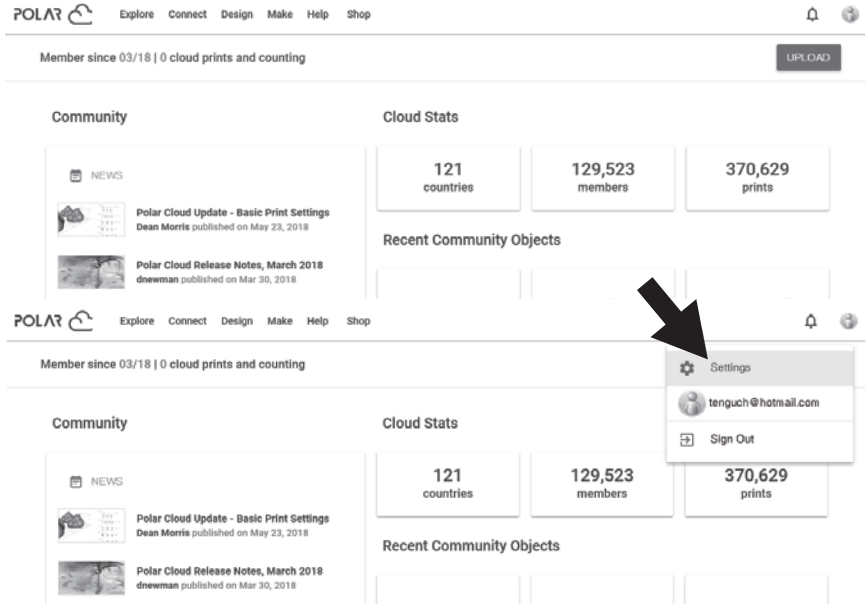

(1). After completing the Polar cloud registration and log in the Polar cloud website, click the icon on the top right corner and click [Settings].

Location

Biography

Website URL

http://www.example.com/profile

Email

+ADD Email

PIN Code
XXXX



(2). Find the PIN Code column below the page, and the shown number is PIN code.

3. Connect the Adventurer 3 to the internet.

Choose the appropriate network connection mode in the communication interface to connect the network (see the 2.3.2.1 section of the connection method).

4. Connect the Adventurer 3 to the Polar cloud.

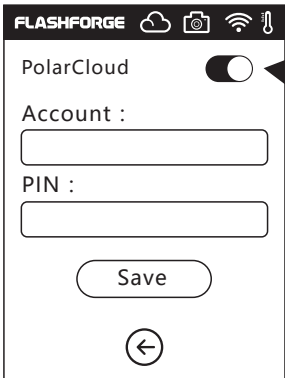

Polar cloud switch



Enter the cloud connection interface (click tools > communication > cloud connection), turn on the Polar cloud switch (After the Polar cloud is turned on the switch will change into green). Fill in the below account and PIN code columns with the account before the registration of Polar cloud and the PIN code queried before, click save.

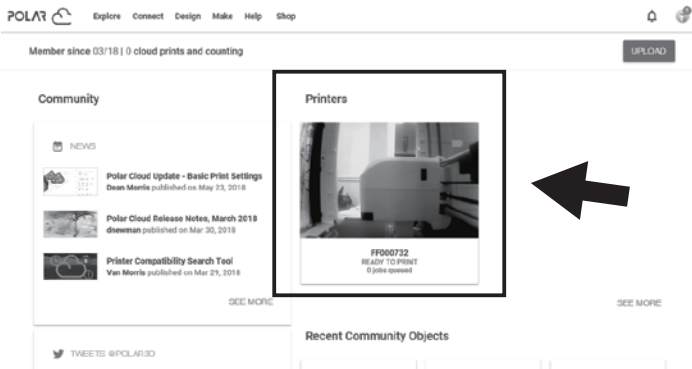

5. After the connection is completed, you can see the printer's information on the front page of Polar cloud website. (if you turn on the camera function, you can see the real time picture on the page).

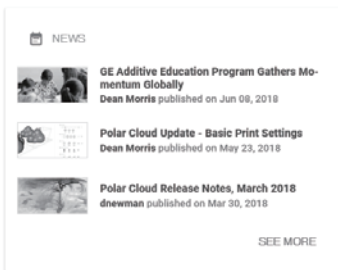

7. Click **[MY OBJECTS]**, then click **[UPLOAD]** to upload the model.

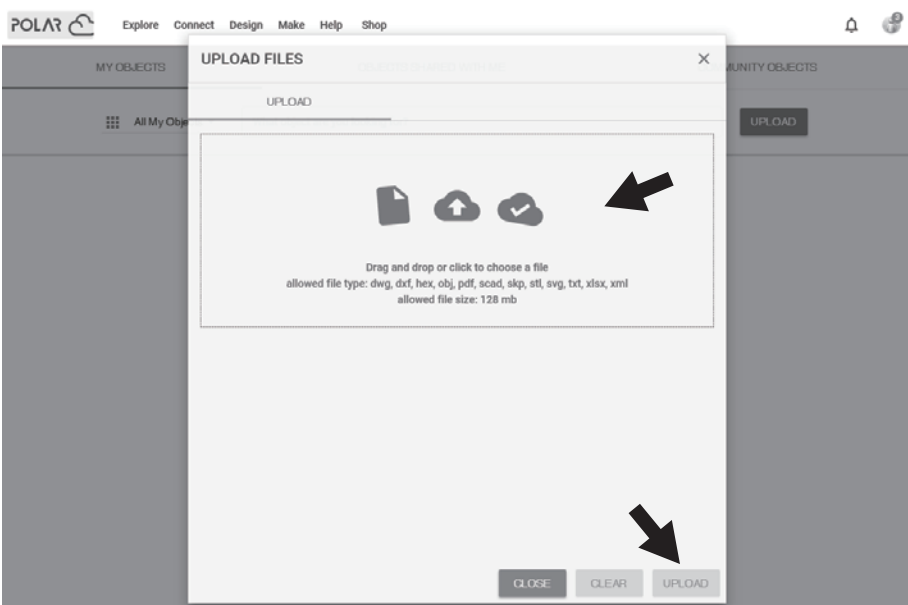



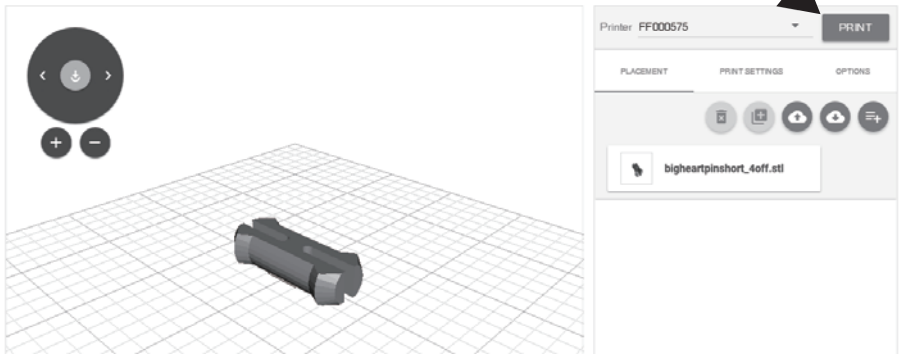

8. Drag and drop the model files that need to be uploaded to the box area or click the box area to select the upload model, then click **[UPLOAD]** to upload.



9. Click **[PRINT]**.



FF000575 ▾

Serial Number: FF000575
Status: READY TO PRINT

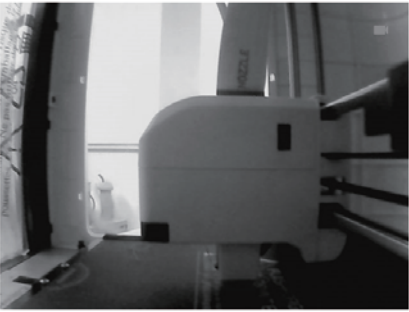

3 jobs queued

 <p>Slicing completed</p>	 <p>Nuka_cola_-_keychai n tenguch@hotmail.com Job 1 3 hours ago</p>	 <p>Nuka_cola_-_keychai n tenguch@hotmail.com Job 2 2 hours ago</p>	 <p>bigheartpinshort_4off n tenguch@hotmail.com Job 3 a few seconds ago</p>
--	---	---	---

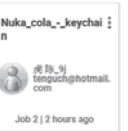
10. Click **[START]**, the printer starts the cloud task downloading, and starts printing when the download is finished.

2.4.4 Model Remove

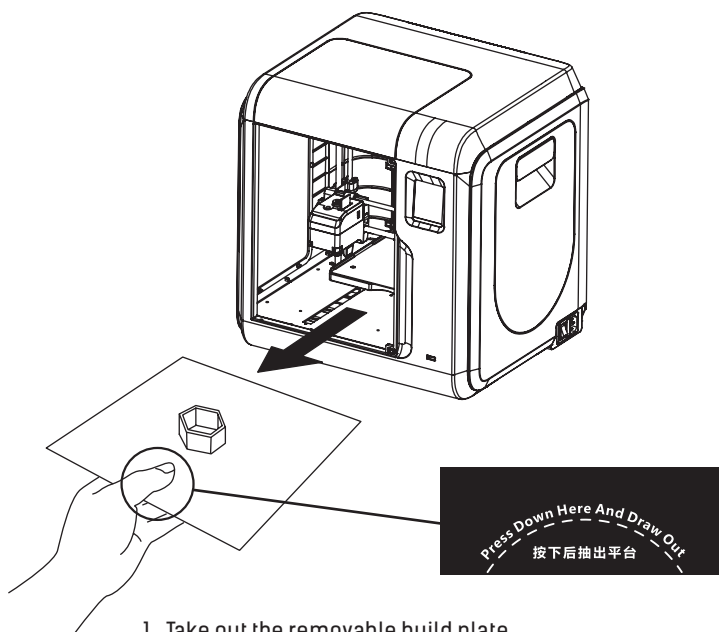

1. Take out the removable build plate.

⚠ Notices

When printing completed, extruder and build plate may still be hot, please start operating after cooling down!

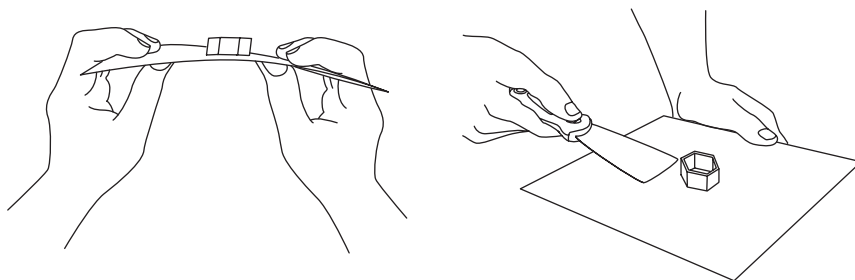

2. Bend the build plate, the plate will produce certain deformation, separating the plate away from the bottom of model (Please use a scraper to assist removing when model is too small or big).

2.4.5 Replace Filament

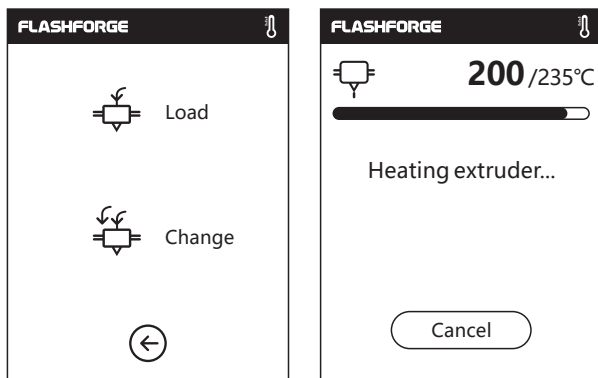

1. Tap [Filament]--Tap [Change], extruder will start preheating.

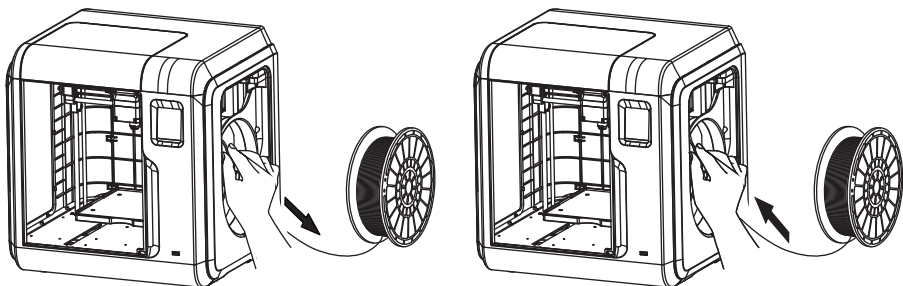

2. Pull out the filament as the picture showed above.

3. Insert new filament into the filament intake and push the filament into the feeding wheel until resistance is sensed.

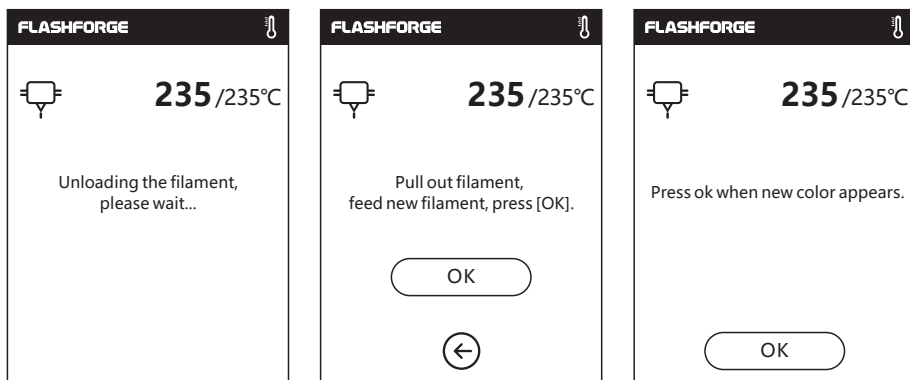

4. When new filament come out of extruder steadily, replace is completed, Tap [OK].

2.5 The Guide of Using Camera

Camera User Manual

Camera and USB Disk use the same interface, so the use of Adventurer 3's camera is different from that of other models. The use of Adventurer 3's camera and the use of Adventurer 3's USB Disk are incompatible (that is, only one (camera or USB Disk) can be used in the same time). The switching between camera and USB Disk can be realized through the Cloud or the lower computer. The use of Adventurer 3's camera is introduced as follows.

2.5.1. The switching can be controlled by the lower computer

In respect of the use of Adventurer 3's camera, there are two modes, that is automatic mode (default mode) and manual mode. The route is (Tools->Settings (on the second page) -> Camera), the user can click the "Camera" button to enter the relevant page.

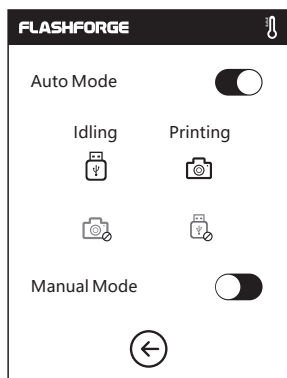

Automatic Mode: When the printer is working (such as the printer is printing the files), the camera is turned on and USB Disk is turned off. When the printer is not working, the camera is turned off and USB Disk is turned on.

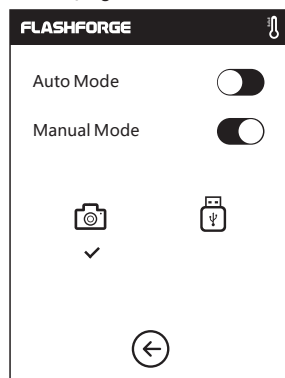

Manual Mode: The switching between camera and USB Disk can be controlled by the user at will.

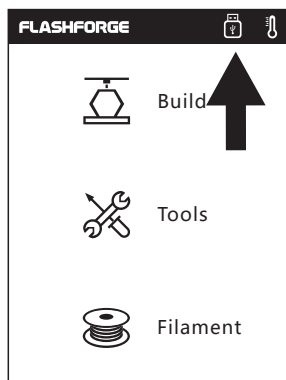
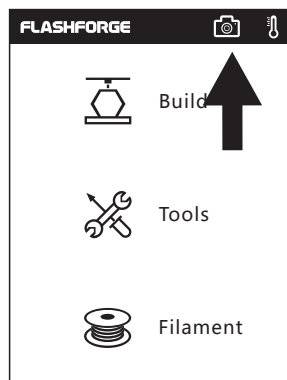

After the camera is turned on successfully, the icon of camera will appear in Status Bar. After the camera is turned off, the icon of USB Disk will appear in Status Bar in case of successful insertion of USB Disk.

2.5.1. The use of FlashForge cloud camera

1. Login FlashForge cloud website and register an account. After the mailbox activation, you can login and use the FlashForge cloud.

FlashForge cloud website:
<https://cloud.sz3dp.com>

Login

E-mail/phone

Password

Remember password

[Forgot password](#) [Register](#)

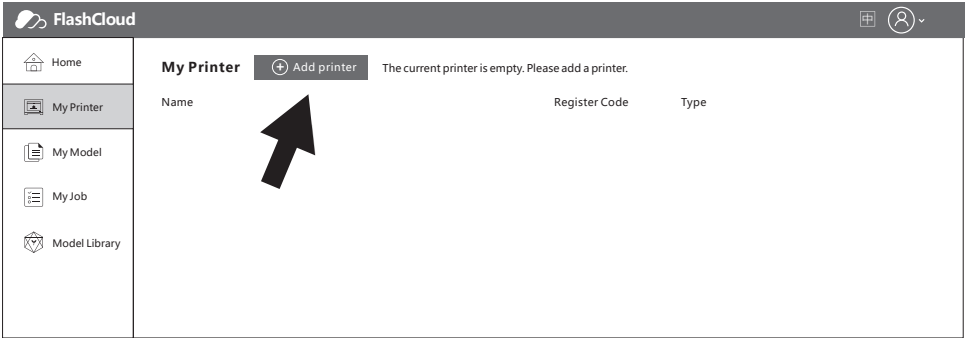

2. After login, click **[My Printer]** – **[Add Printer]**.

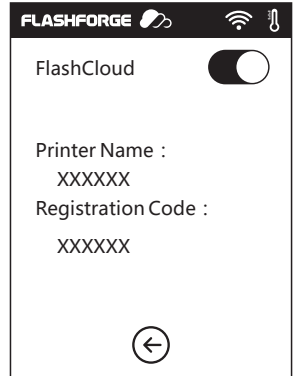
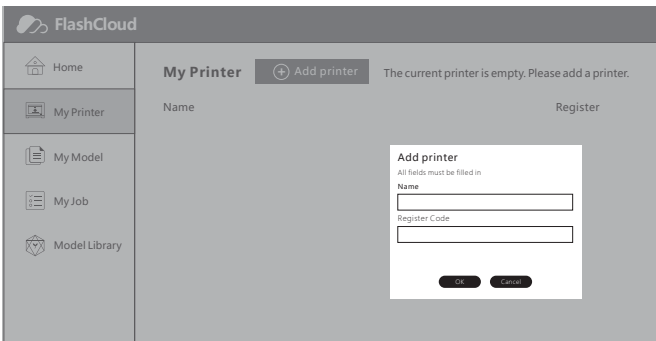

3. Fill in the printer page with the printer name and registration number. This information is displayed on the FlashForge cloud's interface of the printer. Please make sure that the printer has been properly connected to the network (see section 2.3.2.1), the FlashForge cloud function is in the turned on state and the printer is in the camera function (see section 2.5.1).

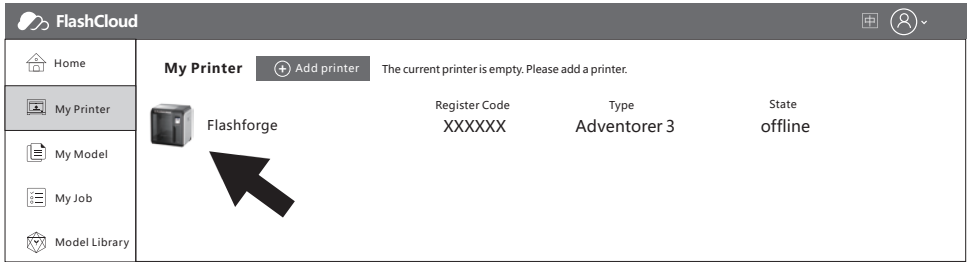

4. Add succeed.

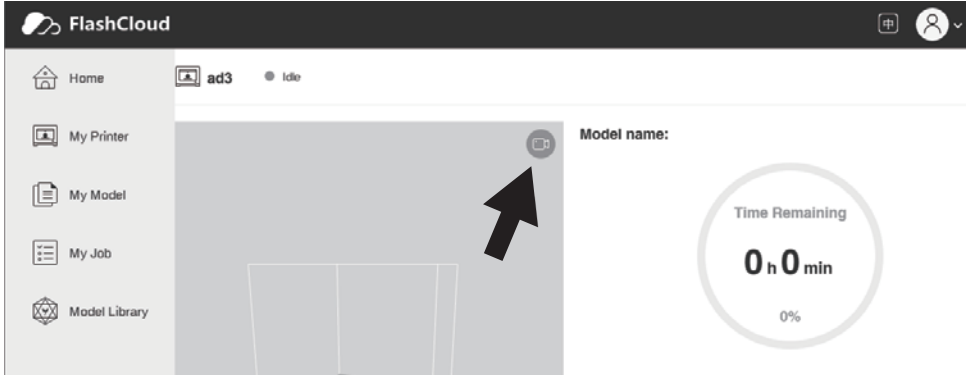

5. Click the camera icon pointed by the arrow.

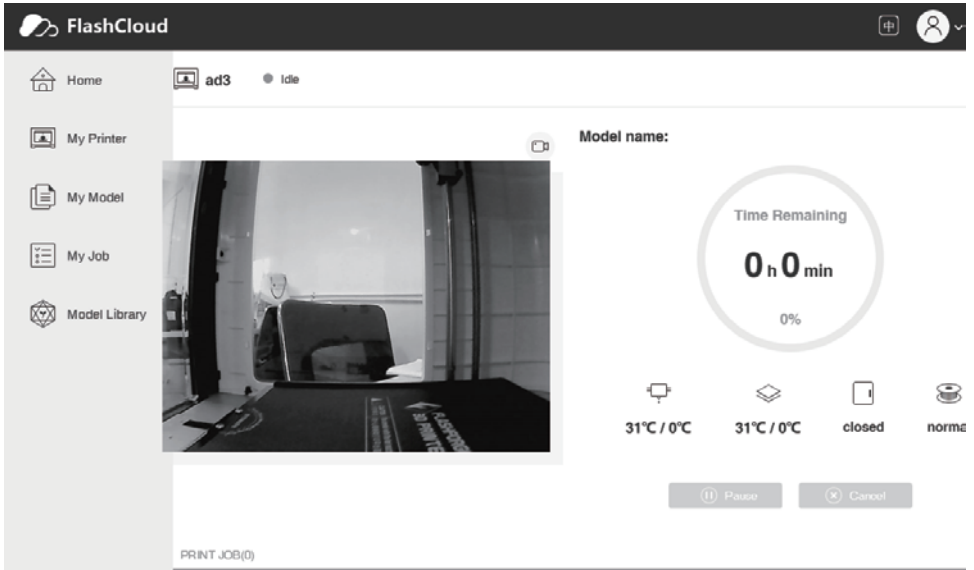

6. Camera begins to work.

2.5.3. PolarCloud camera use

1. Register Polar cloud account
Enter www.polar3d.com website to register account.
2. Find Polar cloud pin code

The image displays two screenshots of the PolarCloud website interface. The top screenshot shows the user profile menu in the top right corner, with a black arrow pointing to the 'Settings' option. The bottom screenshot shows the same page with the 'Settings' option highlighted in a grey box, also with a black arrow pointing to it.

(1). After registering polar cloud and log in polar cloud webiste, click the upper right arrow, click [Settings]

Location

Biography

Website URL

<http://www.example.com/profile>

Email

+ADD Email

PIN Code

XXXX

(2). Find **PIN Code** on the bottom of the page, the display numbers is PIN code.

3. Connect Adventurer 3 to the internet. Choose the proper connecting way in the Network interface (the connecting way consults pagexx).

4. Connect Adventurer 3 to the Polar cloud.

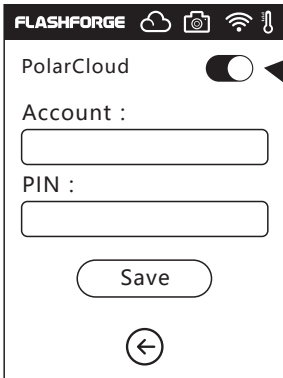

Enter the cloud connection interface (click Tools-Network-Cloud), turn on the Polar cloud switch (After the Polar cloud is turned on, the switch will change in to green).

Fill in the bottom account and pin code column Polar account and Pin code showed before respectively, click Save.

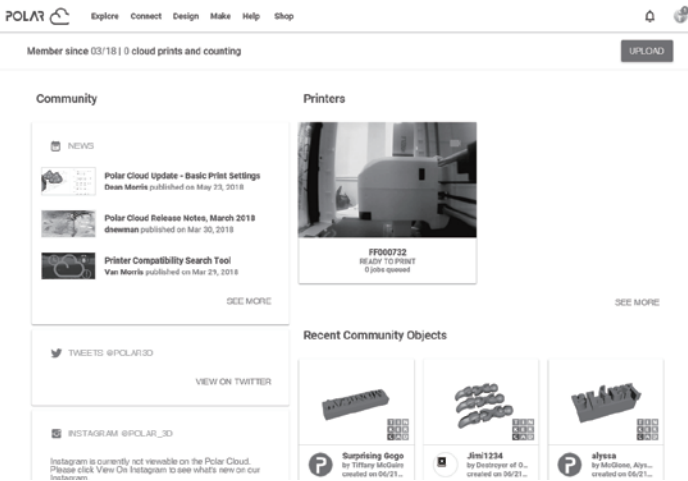

After the connection is completed, you can see the camera image in Polar cloud website.

⚠ Notices

1. Make sure the printer is connected to the internet.
2. When using the camera please make sure the camera is in the camera status instead of USB status. (there should be a camera icon in the status bar).

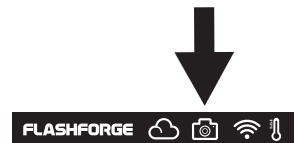

2.5.4. The switching can be controlled through the Cloud

1. Connect to Polar Cloud

The user can turn on or turn off the camera through Polar Cloud. Click Tools-> Communication -> Cloud Connect -> Polar Cloud, enter the settings page of Polar Cloud, click the input boxes of account number and PIN, enter the account number and PIN, click the "Start" button to connect to Polar Cloud. The account number is the mailbox used for sign-up with Polar Cloud; for the acquisition of PIN.

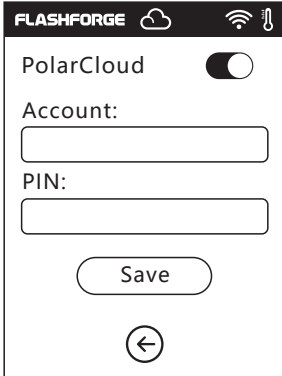

The guide of getting a Polar could account.

The Polar cloud account is the register email account.
Polar cloud website: www.polar3D.com

The way of getting PIN code

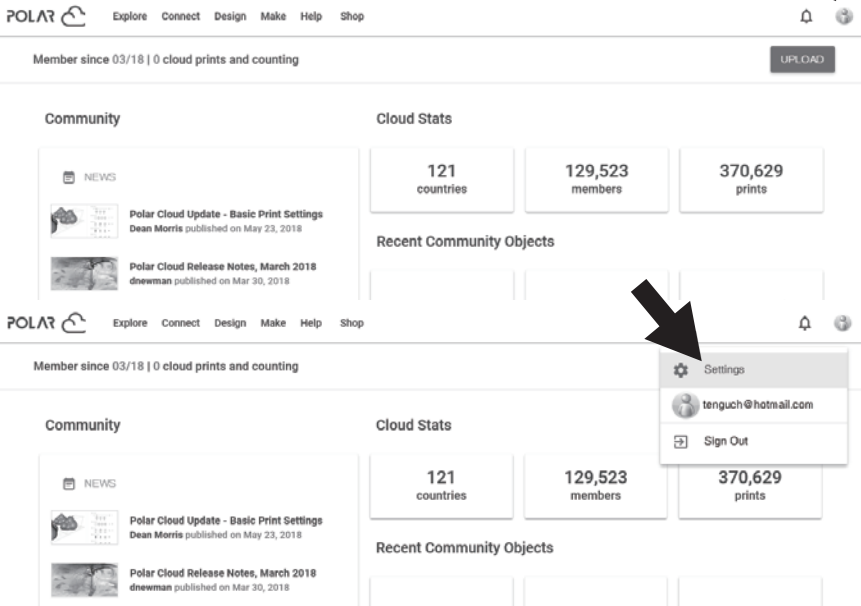

Member since 03/18 | 0 cloud prints and counting

Community

Cloud Stats

121 countries	129,523 members	370,629 prints
---------------	-----------------	----------------

Recent Community Objects

Member since 03/18 | 0 cloud prints and counting

Community

Cloud Stats

121 countries	129,523 members	370,629 prints
---------------	-----------------	----------------

Recent Community Objects

(1). After registering polar cloud and log in polar cloud webiste, click the upper right arrow, click [Settings]

Location

Biography

Website URL

http://www.example.com/profile

Email

+ADD Email

PIN Code

XXXX



(2). Find **PIN Code** on the bottom of the page, the display numbers is PIN code.

2. Open or close the camera through the Cloud.

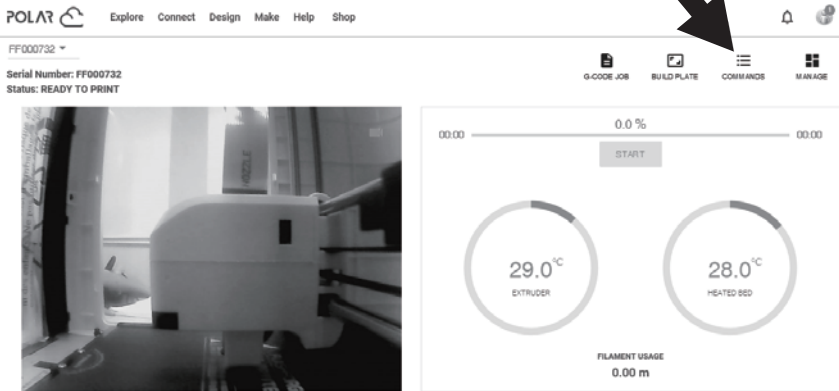

0 jobs queued

(1). After switching on the camera function, click camera image on the front page to enter the interface like this, click the **COMMANDS** button pointed by the arrow.

CUSTOM COMMANDS

open camera

close camera

CANCEL

SEND

(2). You can use check mark to open or close the camera in the pop-up window.

⚠ Notices

- If PolarCloud is in an intranet (that is, the printer and PC connect to the same router), the video is shown, and the state of printing can be displayed in real time. If PolarCloud is in an extranet, the pictures are shown (in case of printing, a picture is sent per 20s; in case of not working, a picture is sent per 60s).
- When the camera is turned on or off, the lower computer will turn off and reconnect PolarCloud, so PolarCloud will not respond for a while. The recovery time depends on the state of network.
- After the camera is operated through the Cloud, the lower computer will set the camera to be in the manual mode; if the automatic mode is to be recovered, please set manually (Tools-> Settings (on the second page) -> Camera).

2.5.5. Error Handling

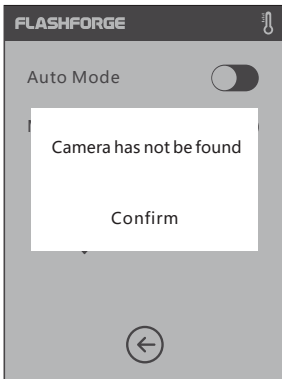

1. When the camera is damaged or not inserted, the error is reported in case of turning on the camera. At this point, the lower computer will automatically set the camera to be in manual mode and the camera is turned off.

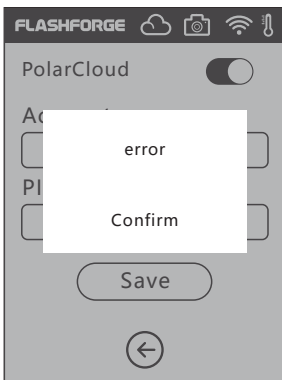

2. If the lower computer does not connect to PolarCloud and the printer is deleted from the Cloud, the error is reported; at this point, the factory settings can be restored in order to solve the problem. After the lower computer connects to the printer and the printer is deleted from the Cloud, the sign-up needs to be done again according to the foresaid steps.

Chapter 3: Q&A

Q1. How to solve if the nozzle is clogged ?

Method 1: Tap [Preheat], heat up the extruder to 240°C, after heating completed, press the air tube joint and pull out the filament guide tube. Check to see whether the filament is bended or filament tip is not smooth, cut filament tip smooth and flat, install the guide tube and filament back, Tap [Load] .

Method 2: If method 1 not improving, use an unclogging pin tool to unclog filament.

Method 3: If method 1 and method 2 not improving, please replace the nozzle.

Q2. How to replace the nozzle ?

⚠ Notice

Power off before replacing nozzle! Make sure power off operation!
Please make filament tip smooth and flat when cutting off the filament.

1. Press the left and right clips and pull out the nozzle.
2. Push in a length of filament through the filament intake manually, making it long enough to be cut off.
3. Rotate the filament spool anti-clockwise manually, making filament retreat back a little.
4. Press the left and right clips, install the new nozzle back into the extruder, making the nozzle slot and bottom of extruder are on the same level.
5. Tap[Filament] -- Tap[Load], nozzle replace completed when you see filament come out of new nozzle.

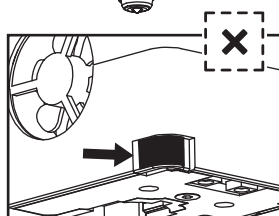
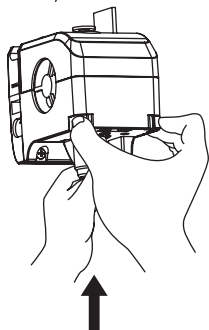
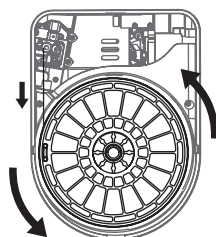
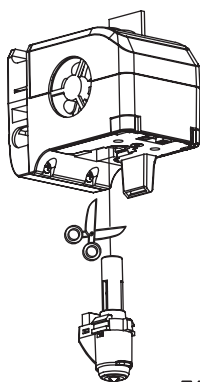
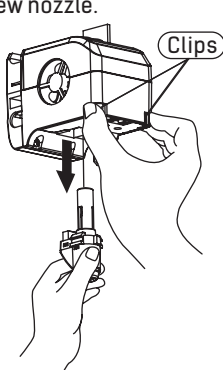

The buckle is not installed in place

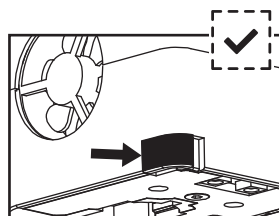

The buckle is installed in place

Whether the assembly of the sprinkler is in place is judged as follows:

1. When installing, must press the sprinkler hard to the end.

2. Check whether the installation is in place:

(1) Touch the black buckle and white sprinkler's lower shell, make sure no sunken.

(2) Look at the black buckle and white sprinkler's lower shell, make sure there is not a large gap in the contact.

Q3. Do we need to do extruder calibration again after replacing nozzle?

Yes, do extruder calibration again to ensure high print quality as minimal error may be caused by extruder installation.

Q4. How to solve if displayed temperature is abnormal after replacing nozzle?

Abnormal temperature indicates extruder sensor can not be read, please check the nozzle whether it is well installed.

Q5. How to solve if no filament come out of extruder after tap [Build] model file and extruder begins moving normally?

1. Check the filament guide tube, make sure filament has been pushed into the extruder, if not, please tap [Load]. Restart building model file after you see filament come out of extruder.
2. Check the nozzle whether it is clogged or not, if so, please refer to Q1 for resolution.

Q6: How to replace the filament ?

1. Tap[Filament]--Tap[Replace], after extruder heating up completed, filament will be unloaded, pull out the filament according to the instruction.
2. Insert new filament into the filament intake and feeding wheel, tap [OK]; New filament will be pushed into the extruder.
3. Replace will complete when you see new filament come out of extruder.

Q7: How to take down the model ?

1. Take out the removable build plate.
2. Bend the build plate, the plate will produce certain deformation, seperating the plate away from the bottom of model. (Please use a scraper to assist removing when model is too small or too big).
3. Take down the model.

Q8: How to solve if the distance between nozzle and platform is too large(far away) or too small(hit) during printing?

1. Tap[Setting]--Calibration.
2. The extruder homing automatically, moves down some height.
3. Tap up and down arrow to adjust the distance between extruder and platform until extruder is just about to touch platform.
4. Tap[OK], printer will memorize current calibration position and start homing automatically.

Q9: Can we use other brand filament which is not produced by Flashforge ?

Adventurer 3 support normal ABS and PLA filament but different brand filament has different ingredients. Adventurer 3 tests out default settings according to the properties of Flashforge ABS and PLA filament.

Other brand filament is ok but not recommended for using, if that causes extruder clogging or bad printing quality or other failure, FlashForge will take no responsibility. These problems are not in the warranty of FlashForge .

Q10. Is Adventurer 3 compatible with all kinds of AC power input ?

Adventurer 3 is equipped with a built-in 24V/6.5A power supplier, suitable for 110V-240V input voltage.

Q11. Is Adventurer 3 capable to be turned off automatically after printing job is finished ?

No.

Q12. What kinds of file formats does Adventurer 3 support?

Input: 3mf / stl / obj / fpp / bmp / png / jpg / jpeg files.
Output: gx/g files.

Q13. Does Adventurer 3 support other cloud platform besides the FlashCloud?

Yes, Adventurer 3 interface is open up to all other cloud platforms.

Q14. Is the ABS printing safe?

ABS filament will give off certain poisonous gas when heated up, please put the printer in well ventilated condition when printing ABS. We suggest printing non-toxic PLA filament when printer is used in children activity places.

Q15. How to solve if printing result has edge warp?

Method1: Heating up the platform can solve or minimize the problem by increasing adhesion between platform and model.

Method2: Adding raft to model when slicing in FlashPrint.

Method3: Apply the solid glue to platform before printing.

Q16. Is it a must to add a raft before printing the model?

Not necessarily, much more filament will come out of extruder when printing the raft, increasing printing success. Heating up the platform also increases printing success by increasing adhesion between platform and model.

Q17. After replacing nozzle completed, printer status displays extruder temperature is 300°C, extruder fan is also working, what is the problem and how to solve?

The new nozzle is not properly installed, extruder temperature can not be read and the displayed extruder temperature is abnormal. Please plug out and install the nozzle again, push nozzle to the end, make sure the nozzle slot and bottom of extruder are on the same level.

Q18. The extruder makes out chug noise and no filament come out of extruder, what is the problem and how to solve ?

Filament has not loaded into extruder, making out chug noise, more likely the nozzle is clogged or filament guide tube is not properly installed. Check the guide tube joint first, if the guide tube is normal, refer to Q1 for resolution.

Q19. What is the difference between filament load and filament replace ?

Load: Only include loading filament into extruder;

Replace: Include loading and unloading two functions, first unloading and then loading filament.

Q20. Adventurer3 starts printing when the distance between extruder and build plate is still large, causing filament can not stick to build plate and print fails.

Do the printer Calibration again or do the Homing again, then print again to check result.

Q21. You cannot find printing files when you use USB driver.

USB driver file is not corrected. Adventurer3 only supports FAT32 file system, please format USB driver into FAT32 file system.

Daily Maintenance Instruction:

Please apply lubricate grease to printer guide rods if you do not use it for long, or do the same maintenance once a month.

Chapter 4: Supports and Service

FlashForge team is on standby and ready to help you with any challenges you may have with your Adventurer 3. If the issues or questions are not covered in this User Guide, you can seek for solutions on our official website or contact us via telephone.

There are solutions and instructions to common issues that can be found in our knowledge base. Have a look first as most basic questions are answered there.

www.FlashForge.com

The FlashForge support team can be reached by e-mail or phone between the working hours of 8:00 a.m. to 5:00 p.m. PST Monday through Saturday. In case you contact us during off-duty time, your inquiry will be answered the following business day.

Note: Because of changing different filament the extruder maybe blockaded. It's not owing to quality issue, and outside the scope of 400 hours life. If users encounter this problem, please contact our after-sale department and finish clean work according to their instruction.

QQ: 2850862986 2850863000 2853382161

Email: support@ff3dp.com

aftersales@flashforge.com

ADD: No. 518, Xianyuan Road, Jinhua, Zhejiang, China.

When contacting support, please have your serial number ready. The serial number is a bar code on the back of your Adventurer 3.



S/N: FFAD*****

FCC Statement

Any Changes or modifications not expressly approved by the party responsible for compliance could void the user's authority to operate the equipment.

This device complies with part 15 of the FCC Rules. Operation is subject to the following two conditions:

- (1) This device may not cause harmful interference, and
- (2) This device must accept any interference received, including interference that may cause undesired operation.

FCC Radiation Exposure Statement:

This equipment complies with FCC radiation exposure limits set forth for an uncontrolled environment. This equipment should be installed and operated with minimum distance 20cm between the radiator & your body.

Note: This equipment has been tested and found to comply with the limits for a Class B digital device, pursuant to part 15 of the FCC Rules. These limits are designed to provide reasonable protection against harmful interference in a residential installation. This equipment generates, uses and can radiate radio frequency energy and, if not installed and used in accordance with the instructions, may cause harmful interference to radio communications. However, there is no guarantee that interference will not occur in a particular installation. If this equipment does cause harmful interference to radio or television reception, which can be determined by turning the equipment off and on, the user is encouraged to try to correct the interference by one or more of the following measures:

- Reorient or relocate the receiving antenna.
- Increase the separation between the equipment and receiver.
- Consult the dealer or an experienced radio/TV technician for help.
- Connect the equipment into an outlet on a circuit different from that to which the receiver is connected.



YouTube

Scan QR to Get More After-Sales Support



Twitter



Facebook



Official Website



Tel: +86 579 82273989 Web: www.flashforge.com Add: 2/F, No.518, Xianyuan Road, Jinhua, Zhejiang, China